



**Nicolet iS50 FT-IR Spectrometers**

# **iS50 NIR Module**

## **User Guide**

269-277700 Revision A

June 2012

© 2012 Thermo Fisher Scientific Inc. All rights reserved.

Nicolet, OMNIC, Antaris, ValPro and RESULT are registered trademarks of Thermo Fisher Scientific Inc. in the United States.

Kimwipes is a registered trademark of Kimberly-Clark Corporation in the United States and possibly other countries.

Spectralon a registered trademark of Labsphere, Inc. in the United States and possibly other countries.

All other trademarks are the property of Thermo Fisher Scientific Inc. and its subsidiaries.

For U.S. Technical Support, please contact:

Thermo Fisher Scientific  
5225 Verona Road  
Madison WI 53711-4495 U.S.A.  
Telephone: 1 800 532 4752  
E-mail: [us.techsupport.analyze@thermofisher.com](mailto:us.techsupport.analyze@thermofisher.com)  
World Wide Web: <http://www.thermo.com/spectroscopy>

For International Support, please contact:

Thermo Fisher Scientific  
Telephone: +1 608 273 5017  
E-mail: [support.madison@thermofisher.com](mailto:support.madison@thermofisher.com)  
World Wide Web: <http://www.thermo.com/spectroscopy>

Thermo Fisher Scientific Inc. provides this document to its customers with a product purchase to use in the product operation. This document is copyright protected and any reproduction of the whole or any part of this document is strictly prohibited, except with the written authorization of Thermo Fisher Scientific Inc.

The contents of this document are subject to change without notice. All technical information in this document is for reference purposes only. System configurations and specifications in this document supersede all previous information received by the purchaser.

**Thermo Fisher Scientific Inc. makes no representations that this document is complete, accurate or error-free and assumes no responsibility and will not be liable for any errors, omissions, damage or loss that might result from any use of this document, even if the information in the document is followed properly.**

This document is not part of any sales contract between Thermo Fisher Scientific Inc. and a purchaser. This document shall in no way govern or modify any Terms and Conditions of Sale, which Terms and Conditions of Sale shall govern all conflicting information between the two documents.

**For Research Use Only. This instrument or accessory is not a medical device and is not intended to be used for the prevention, diagnosis, treatment or cure of disease.**



**WARNING** Avoid an explosion or fire hazard. This instrument or accessory is not designed for use in an explosive atmosphere.

## iS50 NIR Module

The optional Thermo Scientific iS50 NIR module offers convenient, reproducible diffuse reflection sampling with the Nicolet™ iS™50 spectrometer using the integrating sphere or a fiber optic accessory.

**Figure 1.** iS50 NIR Module

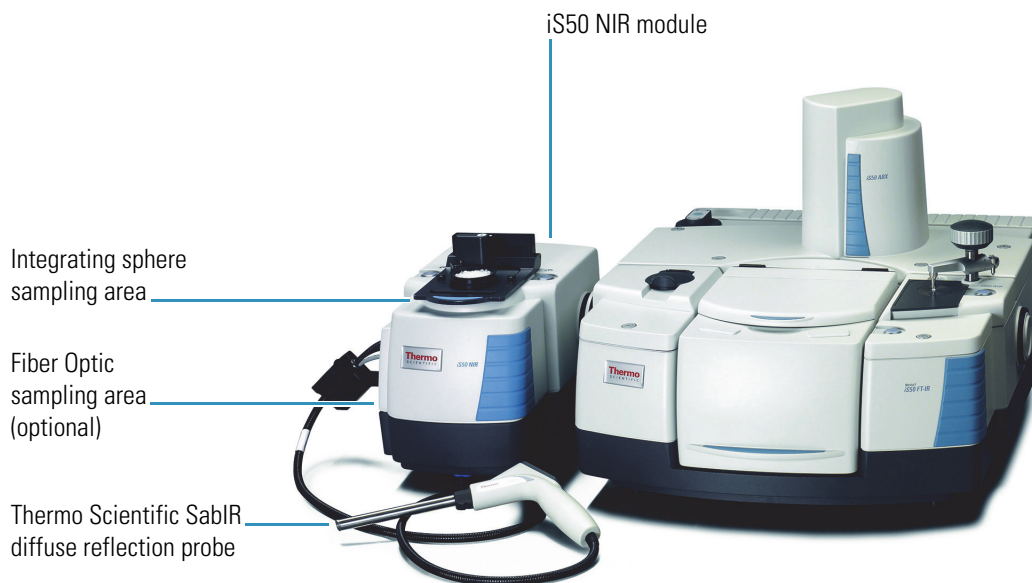

The iS50 NIR module mounts on the left side of the spectrometer.

The iS50 NIR module provides these enhanced features:

- Integrated design
- Push button configuration
- Two sampling options, local (integrating sphere) and remote (fiber optic, optional)
- Up to two dedicated detectors
- Automated internal reference
- Standards wheel (contains 2%, 10%, 20%, 40%, and 80% glass filters and a polystyrene sample)

The optional fiber optic sampling area can be used with the **Thermo Scientific SabIR diffuse reflection probe**, or with probes from other manufactures if the probes have SMA connectors. For information about additional sampling modules for the Nicolet iS50 spectrometer, contact our sales representative in your area.

The optional **ValPro Qualification** software can be used with the standards wheel for qualifying the NIR module's performance. Refer to your ValPro™ documentation details.

**Contents**

- [Operating Precautions](#)
- [Specifications](#)
- [Compatible Software](#)
- [Integrating Sphere Sampling](#)
- [Fiber Optic Sampling](#)
- [Using the Optional SabIR Probe](#)
- [Using Fiber Optic Accessories from Other Manufacturers](#)
- [Maintenance](#)

For general information about the NIR diffuse reflection technique including compatible samples, processing, searching and analyzing diffuse reflection spectra, please refer to the document or help topic titled “NIR Sampling.”



**NOTICE** Be sure that all persons operating this system read the site and safety manual first.

**Conventions Used in This Manual**

This manual uses these conventions for providing safety and other special information:



**CAUTION** Indicates a hazardous situation which, if not avoided, could result in minor or moderate injury.

**NOTICE** Follow instructions with this label to avoid damaging the system hardware or losing data.

**Note** Contains helpful supplementary information.

**Tip** Provides helpful information that can make a task easier.

## Operating Precautions

Before using the iS50 NIR module, read these operating precautions to avoid damaging your equipment.

### Precautions for the integrating sphere:

- Do not pour liquids directly onto the integrating sphere.
- Do not use harsh detergents, chemicals or abrasives to clean the surface of the integrating sphere; these can damage the finish.
- Make sure your sample materials will not react with the sapphire crystal sampling window.
- Use solvents that do not react with sapphire crystals when cleaning the sampling window.
- Avoid scraping the sampling window with samples or sample containers.
- Protect the electrical port on the surface of the integrating sphere. If the connector is clogged or jammed, contact a Thermo Scientific service representative.

### Precautions for fiber optic cables:

- Do not drop the cables or knock them against a hard surface.
- Do not bend the cables or tightly coil them. The radius of the coils for the SabIR probe should be at least 30 cm. For other fiber optic accessories, refer to their user guides.
- Avoid twisting the cables when attaching the connectors to the ports.
- Do not overtighten or use tools to tighten the connectors when attaching the cables to the ports.
- Do not touch the end of a fiber optic cable connector or use solvents to clean it.
- Keep a protective cap on each end of the cable when it is not in use.

### Precautions for the SabIR™ probe:

- Do not drop the probe or knock it against a hard surface.
- Do not subject the probe to rapid or excessive changes in temperature.
- Wipe off spilled chemicals immediately.
- Make sure your sample material will not react with the sapphire sampling window.
- Do not allow hard materials (glass, metal, ceramic, etc.) to contact the sampling window.

- Use solvents that do not react with sapphire crystals when cleaning the sampling window.
- Power off the instrument before connecting the SabIR probe.
- Make sure the probe is clean before you insert it into the holster.
- Do not use the probe by itself to measure liquids. When sampling liquids, use the transmittance adapter available for the probe.

## Specifications

**Table 1.** Specifications for the integrating sphere sampling area

Feature	Specification
Crystal material	Sapphire
Internal reference	Diffuse gold
Detector	Dedicated Indium Gallium Arsenide (InGaAs)

**Table 2.** Specifications for the optional fiber optic sampling area

Feature	Specification
Fiber optic connectors	SMA type
Detector	InGaAs
Probe (optional)	Thermo Scientific SabIR diffuse reflection probe
SabIR probe internal reference	Spectralon™

The NIR module spectral range is dependent upon the spectrometer configuration. The table below shows the available configurations and their corresponding spectral ranges.

**Table 3.** NIR module available spectral ranges

Source	Beamsplitter	Detector	Spectral range
White light	CaF <sub>2</sub> <sup>a</sup>	InGaAs <sup>b</sup>	12,000 - 3,800 cm <sup>-1</sup>
White light	XT-KBr <sup>c</sup>	InGaAs <sup>b</sup>	11,000 - 3,800 cm <sup>-1</sup>

<sup>a</sup>Calcium Fluoride

<sup>b</sup>Indium Gallium Arsenide

<sup>c</sup>Extended range Potassium Bromide

**Note** The iS50 NIR module requires a CaF<sub>2</sub> window installed in the external beam port on the left side of the spectrometer.

## Compatible Software

**Table 4.** Software compatible with the NIR module

Software	Use for...
OMNIC™	Configuring the NIR workflow, including quantitative analysis and spectral search, and collecting and analyzing NIR spectra. For more information, see “Your First Experiment” in the “Integrating Sphere Sampling” section or the “Fiber Optic Sampling” section.
OMNIC Spectra™	Analyzing unknowns. This software includes our unique multi-component search feature for identifying the spectra of mixtures, a 9,000 compound spectral database, and features for using your computer’s hard drive as a library. For more information, refer to the help system in OMNIC Spectra software.
TQ Analyst™	Creating quantitative and classification methods that can be used with OMNIC or RESULT™ software. TQ Analyst software provides an extensive suite of chemometrics features you can use to identify raw materials, perform quantitative analysis, and take spectral measurements. For more information, refer to the help system in your TQ Analyst software.
RESULT	Running integrating sphere or SabIR quantitative methods that have been transferred to any Thermo Scientific Antaris™ near-infrared analyzer that uses RESULT version 3.0 or higher. For information about adding TQ Analyst methods to a RESULT workflow, please refer to your <i>RESULT Integration Software User Guide</i> .  <b>Note:</b> Only methods created in TQ Analyst software version 8.4 or higher can be transferred from OMNIC to RESULT software.

## Integrating Sphere Sampling

The integrating sphere is a fast and easy-to-use tool for diffuse reflection sampling of solids and powders. This section covers:

- [Integrating Sphere Features](#)
- [Samples Compatible with the Integrating Sphere](#)
- [Your First Experiment](#)
- [Collecting Backgrounds with the Integrating Sphere](#)
- [Using a Dark Correction](#)
- [Sampling Accessories for the Integrating Sphere](#)

## Integrating Sphere Features

The major features of the iS50 NIR module integrating sphere are highlighted below.

**Figure 2.** iS50 NIR Integrating sphere sampling area features

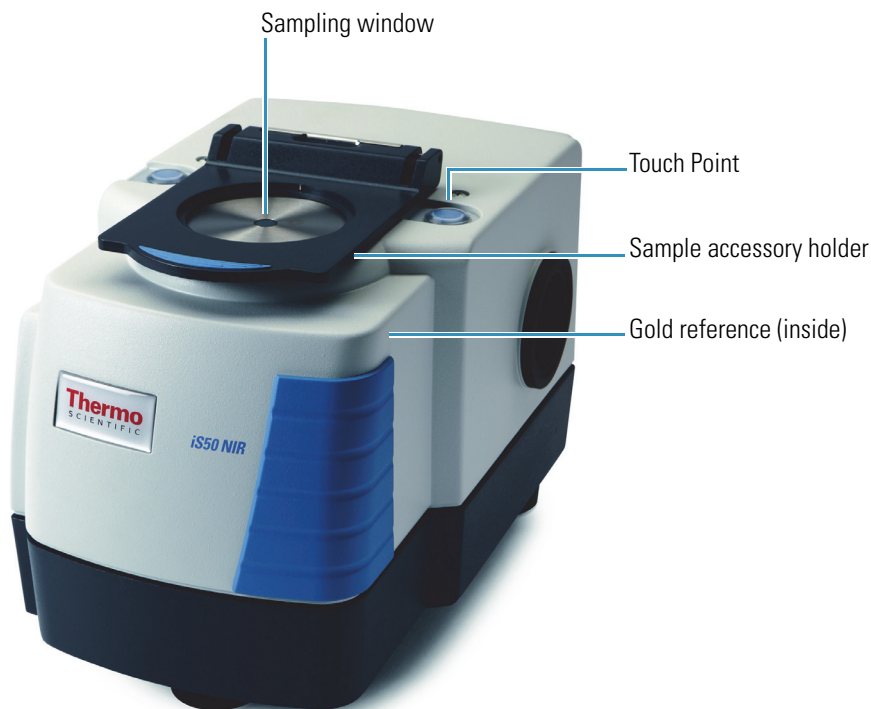

- **Sampling window.** Light from the spectrometer passes through this transparent sapphire window to the sample.



**CAUTION** Avoid eye hazard. Do not stare at the beam that exits the integrating sphere sampling window when the spectrometer is powered on and the Integrating Sphere beam path is selected.

- **Sample accessory holder.** Mounts over the sampling window and holds Thermo Scientific sample cups and tablet holder accessories.
- **Internal gold reference.** Can be used to collect background spectra. When enabled, the reference automatically moves into the beam path during background data collection, and out of the beam path during sample collection.
- **Touch Point.** Automatically configures the spectrometer for integrating sphere sampling. The Touch Point LED (Light Emitting Diode) shows the status of the iS50 NIR module. The LED has three states described below.



**Figure 3.** Integrating sphere status indicator states

LED status	Meaning
On	Ready for use
Off	System is not configured for integrating sphere sampling
Blinking	Optics are reconfiguring

## Samples Compatible with the Integrating Sphere

The integrating sphere can be used to measure a wide variety of samples. Some examples are provided below. Samples may be measured directly or in clear glass or plastic containers.

**Table 5.** Samples compatible with the integrating sphere

Types	Characteristics	Examples
Solids <sup>a</sup>	Must have a rough or diffuse surface	Coated textiles, paper, wood, polymers, and plastics (especially plastics that have a milky, opaque appearance)
Tablets <sup>b</sup>	Must have a reflective surface	White or colored doses of aspirin, acetaminophen or other drugs
Powders, granules, pellets <sup>c</sup>	Particles can be any size, from fine to rough ground up to large pellets	Polyethylene, excipients, flour
Liquids, gels <sup>d</sup>	Must be a suspension or opaque, or use a dip probe	Milk, colloidal suspensions, dispersed solids

<sup>a</sup>Use enough sample to completely cover the integrating sphere window. Place abrasive solids in a clear glass or plastic container.

<sup>b</sup>May be placed directly on the integrating sphere window or in one of the tablet holder accessories.

<sup>c</sup>May be measured in clear glass, flat-bottom vials, clear plastic bags, or in Thermo Scientific sample cups. Fill the sample cup to a depth of at least 5 mm. To improve reproducibility, fill the cup with the powder until it is overflowing and then level it with a spatula. If possible, use a closed sample cup and cover.

<sup>d</sup>Must be measured in clear glass, flat-bottom vials or clear plastic bags. Do not use Thermo Scientific sample cups for liquids. If the liquid is clear, you can analyze it using the SabIR probe with a transmittance adapter. See [Using the Optional SabIR Probe](#) and [Sampling Accessories for the SabIR Probe](#) for more information.

### NOTICE

- Do not pour liquids directly onto the sampling area of the integrating sphere, especially the area around the electrical connector for the Sample Spinner accessory.
- Make sure your sample materials and cleaning solvents will not react with the sapphire sampling window. Refer to the [“Cleaning the Integrating Sphere Sampling Window”](#) section for more information.
- Avoid scraping the sampling window with samples or sample containers.

A variety of **accessories** are available for fast, reproducible sampling of tablets, pellets, powders and gels. For more information, please refer to the “[Sampling Accessories for the Integrating Sphere](#)” section.

**Sample thickness** or the amount of sample should be taken into consideration when using the integrating sphere. If a solid sample is too thin or if there is not enough of a powder sample, you may encounter problems with the spectra.

## Your First Experiment

This section explains how to configure your integrating sphere workflow and demonstrates how to use the integrating sphere to analyze a sample.

### Configuring Your Integrating Sphere Workflow

The integrating sphere Touch Point has an associated user-configurable workflow that can define everything from background and sample collection to quantitative analysis and spectral search. You simply press the Touch Point to start the workflow. The Touch Point can also be used to respond to prompts in the software while the workflow is running.

#### ❖ To configure your integrating sphere workflow

1. Start OMNIC software.

The OMNIC window is displayed. For information about the OMNIC window, choose Help > OMNIC Help Topics.

2. Choose the integrating sphere **Touch Point button** in the software to configure the instrument for integrating sphere sampling.

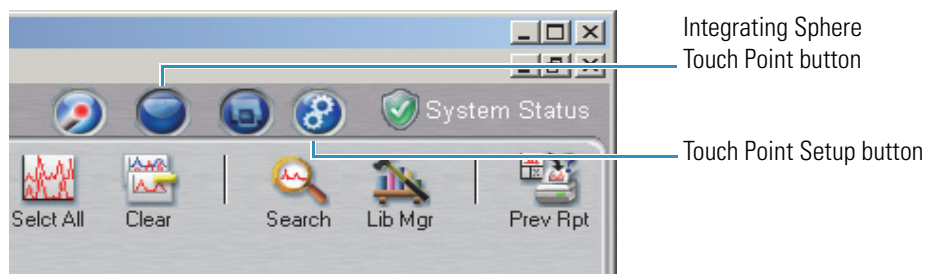

3. Choose the **Touch Point Setup button** in the software.

A dialog box is displayed.

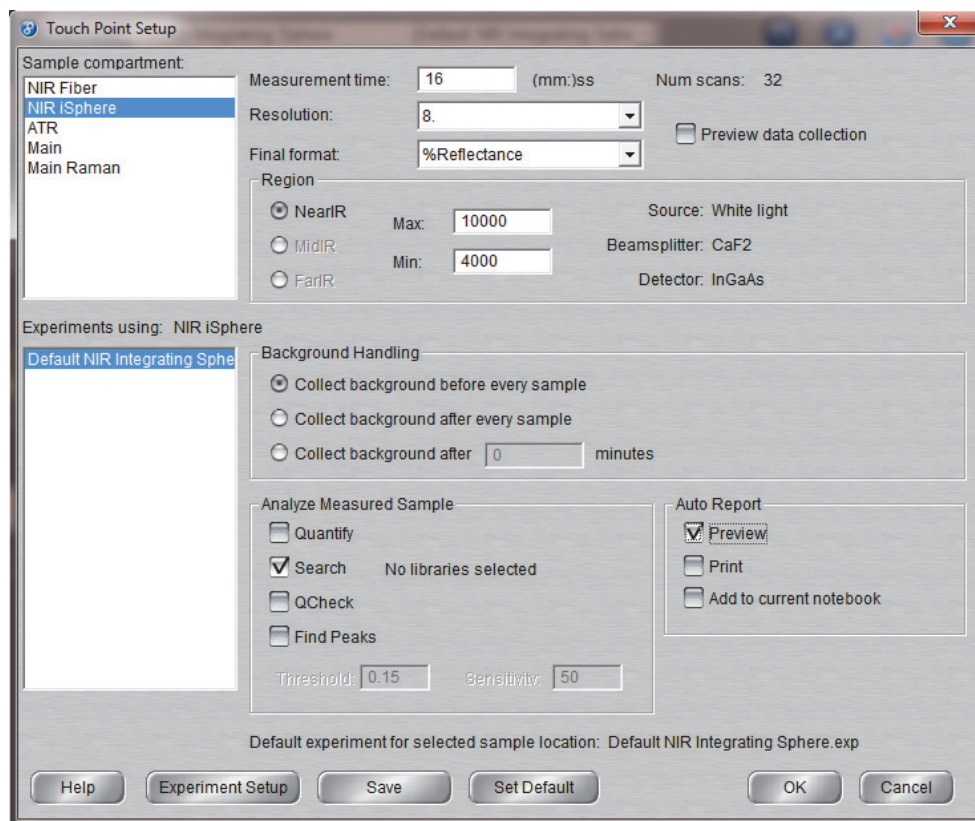

Notice that Sample Location (upper left pane) is set to NIRiSphere, and below that pane is a list of iS50 experiments for the integrating sphere. The selected experiment is highlighted and its associated settings are visible in the dialog box.

The Touch Point Setup dialog box provides commonly used settings that define how your integrating sphere data will be collected, displayed, measured and reported. Brief descriptions are provided below.

**Table 6.** iS50 integrating sphere Touch Point settings

Option	Description
Measurement time	Determines the duration of scanning for sample data collection.
Number of scans	Shows the scans collected for the selected measurement time. Multiple scans are averaged.
Resolution	Sets the spectral resolution of the data you collect. Typically $16\text{ cm}^{-1}$ or $8\text{ cm}^{-1}$ is appropriate for most integrating sphere applications. The smaller the resolution value, the higher (better) is the resolution. The resolution value, along with the number of scans, affects the collection time.

**Table 6.** iS50 integrating sphere Touch Point settings

Option	Description
Final format	Determines the Y-axis unit used for the collected data. Typically set to log(1/R) or %Reflectance for integrating sphere applications.
Preview data collection	Select this option if you want to collect and view (but not save) preliminary data before the start of a sample or background data collection. This lets you verify that your experimental conditions are correct before collecting the spectrum.
Region	Determines the spectral range of the spectrometer that will be used to collect the data. The spectral range is defined by the type of source, beamsplitter and detector used. <b>Near-IR</b> is the only available Region option for the integrating sphere.
Max/Min	Shows the default limits of the integrating sphere detector's spectral range. The Max/Min limits can be reduced to eliminate spectral regions that provide no additional information about the sample.
Background handling	<p>Lets you specify when to collect a background spectrum to be used for ratioing sample spectra you collect. Collecting a background after a specified number of minutes is a good choice for many applications. You will be prompted to collect a background the very first time you collect a sample spectrum.</p> <p><b>Note:</b> The background type (internal or external) is defined on the Bench tab of the Experiment Setup dialog box. Choose the Experiment Setup button to open it. For more information, open OMNIC Help Topics and find the “Setting the NIR Background Type” topic.;reference:internal for integrating sphere</p>
Analyze Measured Sample	<p>Allows you to select and run analyses on the collected sample spectrum. The analysis results are attached to the spectrum and saved in the spectral (.spa or .spg) file. The following analyses are available:</p> <ul style="list-style-type: none"> <li>• <b>Quantify.</b> Finds the concentrations of components in a sample spectrum. For more information, open OMNIC Help Topics and find the “Quantifying a Spectrum” topic.</li> </ul> <p>To select the quantitative analysis method you want to use to quantify a spectrum, choose <b>Analyze &gt; Quant Setup</b>.</p>

**Table 6.** iS50 integrating sphere Touch Point settings

Option	Description
	<ul style="list-style-type: none"> <li>• <b>Search.</b> Identifies an unknown material by comparing the unknown sample spectrum with each reference spectrum in the selected libraries to find the spectra that most closely match the unknown. For more information, open OMNIC Help Topics and find the “Searching a Spectral Library” topic.  Use <b>Analyze &gt; Library Setup</b> to select the reference libraries to be searched.</li> </ul>
	<ul style="list-style-type: none"> <li>• <b>QCheck.</b> Compares spectra to determine their degree of similarity, expressed as a correlation value from 0.0 (no similarity) to 1.0 (the spectra are identical). For more information, open OMNIC Help Topics and search for the “Comparing Spectra with QCheck” topic.  Use <b>Analyze &gt; QCheck Setup</b> to set up the comparison.</li> </ul>
	<ul style="list-style-type: none"> <li>• <b>Find Peaks.</b> Identifies peak locations in a spectrum by finding peaks whose Y values exceed a specified threshold value. The peaks are labeled with their X values. For more information, open OMNIC Help Topics and search for the “Finding Peaks Above a Specified Height” topic. <ul style="list-style-type: none"> <li>• <b>Threshold.</b> The Y value above which peaks can be found.</li> <li>• <b>Sensitivity.</b> Determines how readily shoulders on peaks and small peaks in the baseline will be found.</li> </ul> </li> </ul>
Auto Report	<p>Can be used to automatically display, print or save an auto report of the analysis results. For more information, open OMNIC Help Topics and find “Working with Auto Reports.”</p> <ul style="list-style-type: none"> <li>• <b>Preview.</b> Displays the auto report after the analysis is completed.</li> <li>• <b>Print.</b> Prints the auto report after the analysis is completed.</li> <li>• <b>Add to current notebook.</b> Adds the report to the current report notebook. For more information, open OMNIC Help Topics and find “Adding a Report to a Notebook.”</li> </ul>
Default experiment	<p>Shows the file name of the default experiment for the selected sample location. The default experiments are write protected to prevent them from being overwritten accidentally.</p>

4. Select an appropriate experiment in the “Experiments Using: NIRiSphere” pane.
5. Set the Touch Point Setup options as desired.
6. If you want to overwrite the default settings without overwriting the default experiment, choose **Set Default**.
7. Choose **Save**.
8. If you need to specify other experiment settings, choose **Experiment Setup**, set the options as desired, choose **Save** and then choose **OK** to close Experiment Setup. For more information, choose **Help** from Experiment Setup.

**Note** Some settings appear in Experiment Setup and in Touch Point Setup. Setting these options in one location automatically changes them in the other.

9. Choose **OK** to close Touch Point Setup.

## Measuring a Sample with the Integrating Sphere



**CAUTION** Avoid eye hazard. Do not stare at the beam that exits the integrating sphere sampling window when the spectrometer is powered on and the Integrating Sphere beam path is selected.

### Before You Begin

- Power on the spectrometer and allow the instrument to stabilize for at least an hour (if the instrument has been powered off for more than 20 minutes).
- Make sure the sampling window is clean. Please refer to the “[Cleaning the Integrating Sphere Sampling Window](#)” section for instructions and recommended solvents.
- Have your sample material at hand. For the collection settings in the default workflow, we recommend that you choose one of the following items for your sample:
  - 325 mg aspirin tablet, or
  - A piece of white bond or other paper such as a business card, or
  - A small clear glass or plastic container of sugar or other granular solid.

### NOTICE

- Do not pour liquids directly onto the sampling area of the integrating sphere, especially the area around the electrical connector for the Sample Spinner.
- Make sure your sample materials and cleaning solvents will not react with the sapphire window. Refer to the “[Cleaning the Integrating Sphere Sampling Window](#)” section for more information.
- Avoid scraping the sampling window with samples or sample containers.

**Figure 4.** Solid sample ready for measurement with the integrating sphere

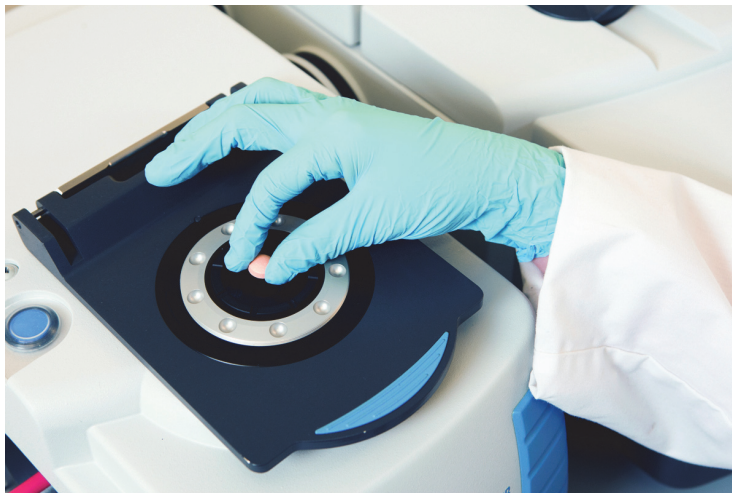

❖ **To measure a tablet with the integrating sphere** [\(watch video\)](#) 

1. Press the **integrating sphere Touch Point** to configure the instrument for integrating sphere sampling and load the default workflow.

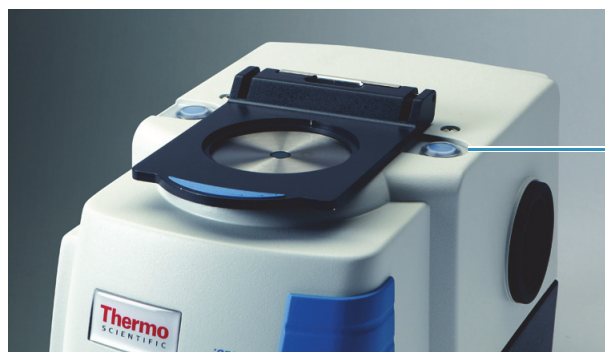

Integrating sphere  
Touch Point

A message may be displayed while the instrument collects scans to determine stability with the new configuration.

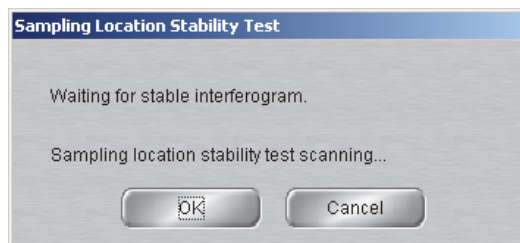

- Wait until the stability test is completed, or choose **OK** to skip that test or **Cancel** to stop all instrument tests. When the stability test is completed, another message may be displayed while the instrument runs a performance test.

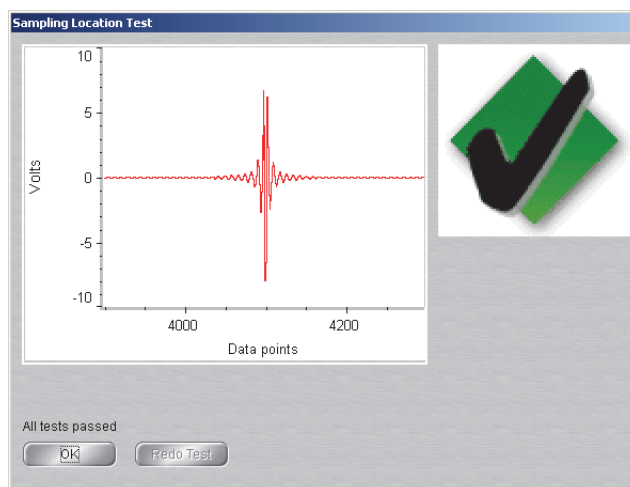

- Wait until the performance test is completed and choose **OK**.
- If your integrating sphere workflow is not configured, follow the steps in the [“Configuring Your Integrating Sphere Workflow”](#) section to configure it.
- Press the **integrating sphere Touch Point** to start the workflow.

If the workflow is set up to collect a dark correction spectrum (that is, if Dark Correct is selected on the Bench tab in the Experiment Setup dialog box), a message asks you to prepare to collect a dark correction spectrum. Follow these steps to collect the correction spectrum:

- Remove any sample from the integrating sphere and choose **OK** (or press the integrating sphere Touch Point) to collect the spectrum. See the [“Using a Dark Correction”](#) section for details.

When the spectrum is completed, a message asks whether to add it to an OMNIC spectral window.

- Choose **Yes** or **press the Touch Point**. The dark correction spectrum is saved whether or not it is added to a window.

If the workflow is not set up to collect a dark correction spectrum, a message asks for a spectrum title.

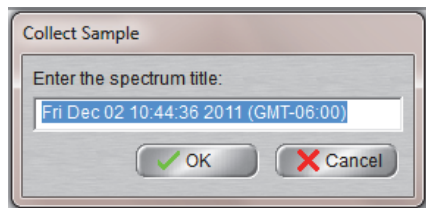

- Enter a title for your sample spectrum and choose **OK** or **press the integrating sphere Touch Point**.



If the software has no appropriate background spectrum in memory and the workflow is set up to collect a background using the internal gold reference, the software begins collecting a background spectrum. You will hear the reference “click” in place, causing all of the light beam to reflect back into the integrating sphere. When the background is completed, you will hear the reference “click” open again. The background spectrum is added to the selected OMNIC spectral window and a message asks you to prepare for the sample collection.

**Note** If the workflow is configured to collect a background using an external reference, a message asks you to prepare for the background collection. Center the reference on the integrating sphere window and press the Touch Point to collect the spectrum. When the background measurement is completed, the spectrum is added to the selected window and a message asks you to prepare for the sample collection. See the “[Backgrounds Taken with an External Reference](#)” section for examples of materials that can be used as an external reference.

7. Place the sample in the center of the integrating sphere sampling window. See the “[Samples Compatible with the Integrating Sphere](#)” section for more information.
8. Choose **OK** or **press the Touch Point** to collect the sample spectrum.

When the spectrum is completed, a message asks whether to add it to a window.

9. Choose **Yes** or **press the Touch Point** to add the spectrum to the selected window and complete the workflow.

If your workflow specifies an analysis such as quantify or search, those steps occur automatically. To see the analysis results, choose the “r” button to the left of the title box above the OMNIC spectral window.

The sample spectrum and its associated analysis results are stored in a virtual report. If your workflow is set up to preview or print auto reports, the report is displayed or printed on the default printer. Below is an example report showing a diffuse reflection spectrum of a business card taken with the iS50 NIR integrating sphere, followed by the results from a spectral search.

**Figure 5.** Auto report showing a diffuse reflection spectrum of adhesive taken with the iS50 NIR module integrating sphere and the results from a spectral search

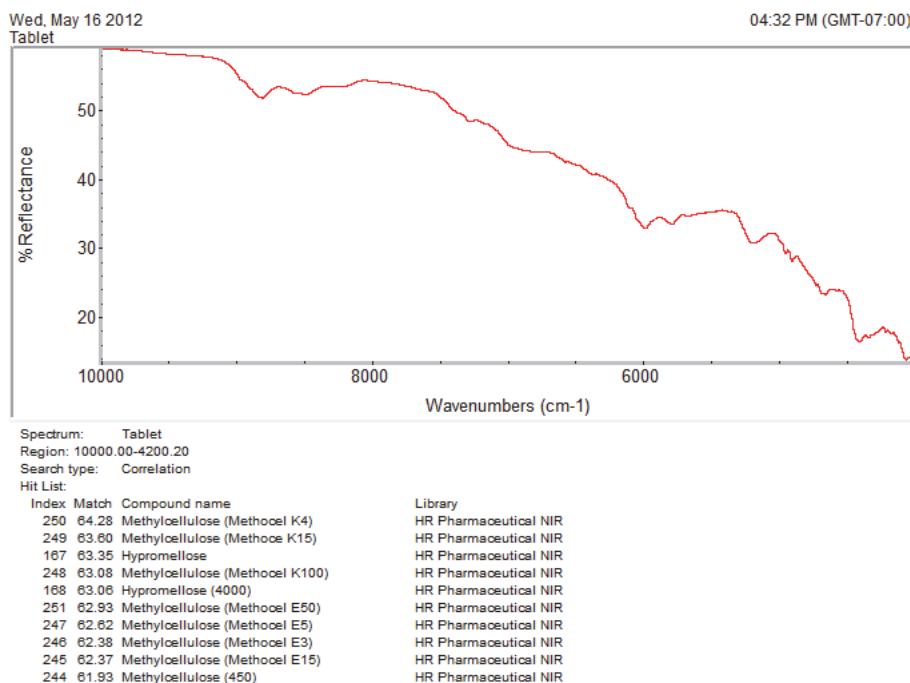

10. Remove the sample and clean the integrating sphere window.

Moisten a clean white paper napkin with isopropyl alcohol and use it to wipe the window.  
Dry the window with a clean napkin.

## Collecting Backgrounds with the Integrating Sphere

A background is a reference spectrum that accounts for the unique optics of the sampling module and the instrument. Each sample spectrum is ratioed against a background so that the final spectrum is free of these features.

You can collect backgrounds using an internal or external reference or using no reference, as directed by the workflow you are running. The workflow will also direct how often to collect a background spectrum. The most recent background spectrum remains in memory and is compared against sample data until a new background spectrum is collected.

### Backgrounds Taken with the Internal Reference

When the internal reference is used, a gold flag located underneath the integrating sphere window closes during background collection, causing all of the light beam to be reflected back into the integrating sphere. A typical background spectrum using the internal reference should resemble the following.

**Figure 6.** Typical gold reference background spectrum taken with the iS50 integrating sphere

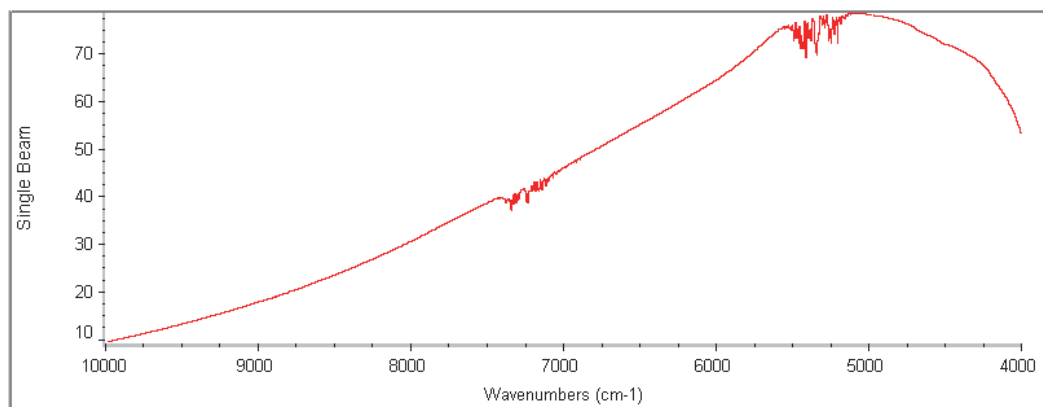

### Backgrounds Taken with an External Reference

When the integrating sphere workflow is configured to collect a background using an external reference, the workflow prompts for a reference before background collection begins. Some examples of materials that can be used as an external background reference include:

- Diffuse gold
- Spectralon, which is a very diffuse substance with high reflectance
- Ceramic

**Tip** Once a material is selected for a background reference, make sure to use the same material each time you run the workflow.

Center the reference over the integrating sphere window and then respond to the prompt by choosing OK or pressing the integrating sphere Touch Point. Do not move the reference until the instrument has finished collecting the data.

### Using a Dark Correction



When taking sample measurements with the integrating sphere or SabIR probe, a small amount of light is reflected off the sampling window and measured by the detector although it contains no additional information about the sample. We provide a way to measure and remove this information from the sample measurement so the reflections in the final spectrum are due solely to the sample.

We call the measurement a “dark correction spectrum.” To set up your workflow to collect a dark correction spectrum and automatically apply the correction to your sample data, choose Collect > Experiment Setup and then select the Bench tab. When Sample Compartment is set to NIR Integrating Sphere or NIR Fiber Optic, a Dark Correction parameter appears in the parameter list. Make sure Dark Correction is selected and save the experiment. For more information about the Dark Correction feature, open OMNIC Help Topics and search for the “Dark Correction” topic.

## Sampling Accessories for the Integrating Sphere

Optional Thermo Scientific accessories for the integrating sphere are described in the table below, followed by additional information. To order an accessory, contact our local sales or service representative or see our contact information at the beginning of this document or help system.

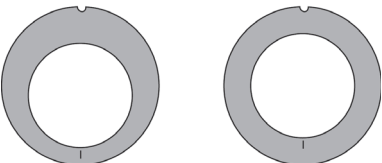
**Table 7.** Optional Thermo Scientific accessories for the integrating sphere

<i>This accessory...</i>	<i>Does this...</i>
<p>Sample accessory holder</p> 	<p>Holds Thermo Scientific sample cups and tablet holder accessories.</p> <p>The sample accessory holder attaches to the top of the iS50 NIR module. The kit includes two sample cup rings: a concentric (centering) ring and an eccentric (offset) ring. The concentric ring can be used to achieve consistent positioning with the sample cups and the sample accessory holder. The eccentric ring works with the sample accessory holder and the 5 cm sample cups to allow sampling over a wider area. Refer to the “<a href="#">Using the Sample Cups and Rings</a>” section for more information.</p>
<p>Sample cup rings</p> 	
<p>5 cm open sample cups</p> 	<p>These come in packages of three sample cups. Each cup has a 4.78 mm low OH quartz window and can be used with the sample accessory holder and sample rings to measure powders. (The open sample cups are not recommended for liquids and gels.)</p>

## Tablet holder kit

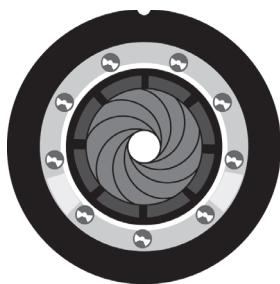

## Universal Tablet Holder

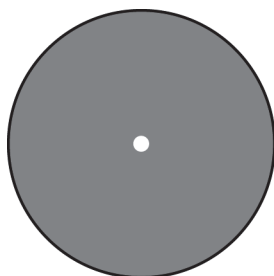

## Custom Tablet Holder

Contains one universal tablet holder, a tablet holder ring, and two custom tablet holders. The tablet holder accessories fit in the sample accessory holder.

The universal tablet holder adjusts to fit snugly around a round tablet for consistent sampling. Please refer to the [“Using the Universal Tablet Holder”](#) section for more information.

The custom tablet holders can be cut to fit the exact dimensions of a tablet. The custom tablet holders require the tablet holder ring. See the [“Using the Custom Tablet Holders”](#) section for details.

## Viscous Liquid Sampler (VLS)



Allows you to run transfection experiments with viscous liquids. The VLS fits in the sample accessory holder. For detailed information about the VLS, please refer to the document or topic with that title.

## 5 cm Sample Spinner

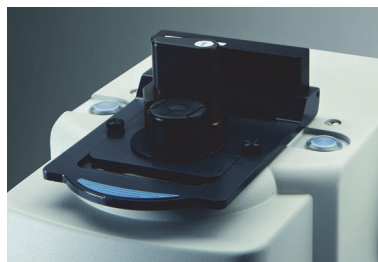

Allows multi-point sampling for large particles such as pellets and grains. The Sample Spinner fits the 5 cm open sample cups. For detailed information about the Sample Spinner, please refer to the document or topic with that title.

## Using the Sample Accessory Holder

### ❖ To install the sample accessory holder ([watch video](#))

1. Insert the tab into the slot.

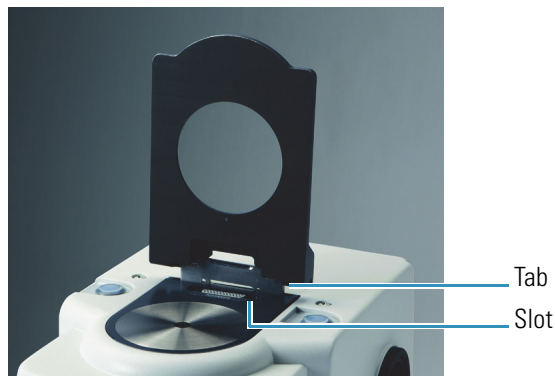

2. Lower the holder onto the NIR module (a magnet holds it in place).



### ❖ To remove the sample accessory holder ([watch video](#))

1. Remove all sampling materials and accessories from the sample accessory holder.
2. Lift the accessory holder until it is perpendicular with the iS50 NIR module, and then carefully pull up on the accessory holder.

## Using the Sample Cups and Rings

When used with the sample accessory holder and the sample cup rings, the sample cups allow you to run multiple collections of a powder in different sampling positions. The **concentric ring** opening is centered around the integrating sphere window and can be used with all sizes of the open and closed sample cups. The **eccentric ring** is offset around the integrating sphere window, and can be used with the 5 cm sample cup to conduct experiments covering all areas of the sample surface.

The sample cup rings have an **indicator** that can be aligned with indentations at 60° increments around the circumference of the sample cups. When performing multiple data collections on a sample, you can use these indicators, along with the indentations in the sample cups, to rotate the sample to repeatable positions.

**Figure 7.** Repeatable positioning using sample cups and rings

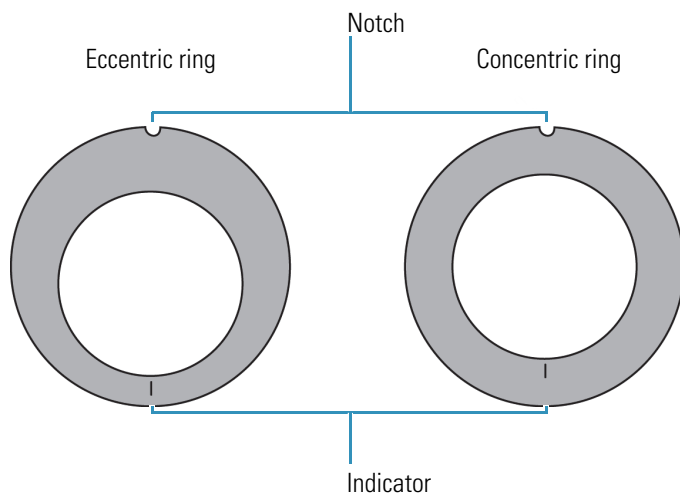

To install a ring, first install the sample accessory holder and then align the notch in the ring with the pin in the accessory holder.

❖ **To fill the sample cups**

1. Fill the cup with the powder until it is overflowing.
2. Use a flat edge to level off the top of the sample cup.

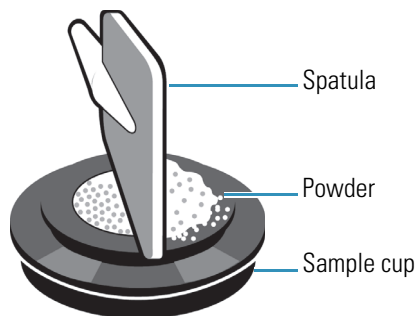

## Using the Universal Tablet Holder

The universal tablet holder can be used along with the sample accessory holder to position round tablets of many sizes and thicknesses on the integrating sphere.

❖ **To install the Universal Tablet Holder (watch video)** 

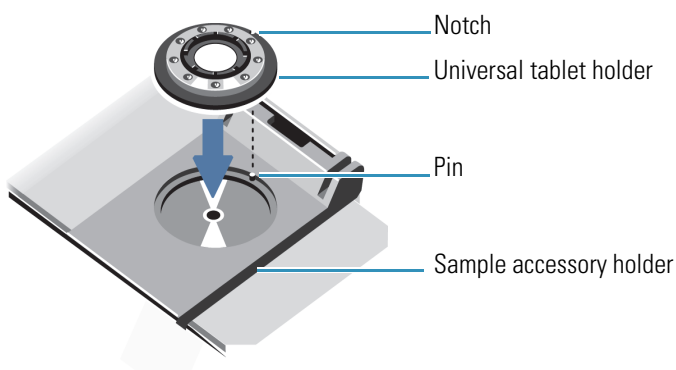

To install the universal tablet holder, align the notch with the pin.

❖ **To adjust the iris**

1. Use your finger to gently turn the black ring to open the iris.

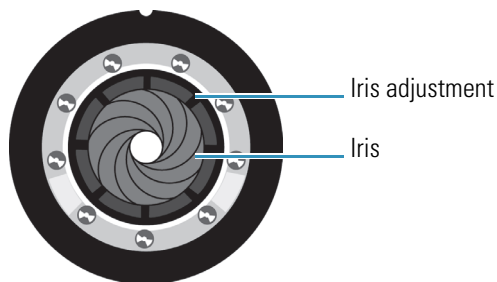

2. Place the tablet in the center of the tablet holder.
3. Adjust the black ring until the iris is almost touching the tablet (see the image below).
4. Use the silver ring to adjust the height of the iris so it is approximately at the center of the tablet's width.

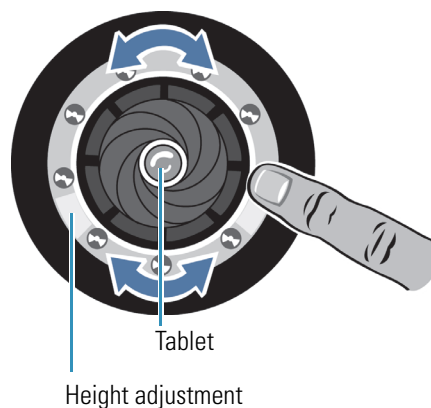
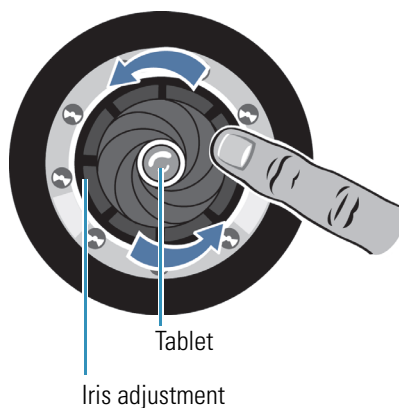



- Gently turn the black ring to close the iris around the tablet.

**NOTICE** Do not overtighten the iris or you may damage it.

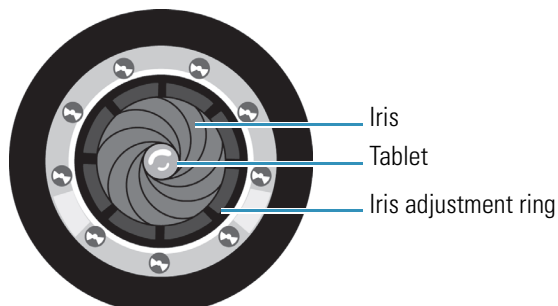

### Using the Custom Tablet Holders

The custom tablet holders are designed to be used with the tablet holder ring, which has a lip around the inside opening (it does not have the position indicators like the sample cup rings).

The custom tablet holders contain a small hole to reference the center of the holder. The hole aligns with the center of the integrating sphere when the custom tablet holder is used with the sample accessory holder and tablet holder ring.

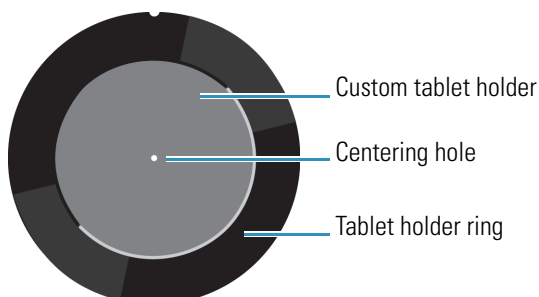

Use a utility knife or die to cut the tablet holder to the precise size of the tablet.

**Tip** If your experiments require a great deal of precision, repeatability, and consistency, consider machining a metal tablet holder that fits the exact dimensions of the tablet and tablet holder ring.

## Fiber Optic Sampling

The optional fiber optic sampling area adds mirrors and ports to direct the near-infrared beam to a pair of input and output optical fibers for remote sampling with a fiber optic accessory. The ports are compatible with fiber optic sampling accessories that use various sampling techniques and have standard SMA connectors, including the optional Thermo Scientific SabIR diffuse reflection probe.

**Figure 8.** iS50 NIR fiber optic sampling area features

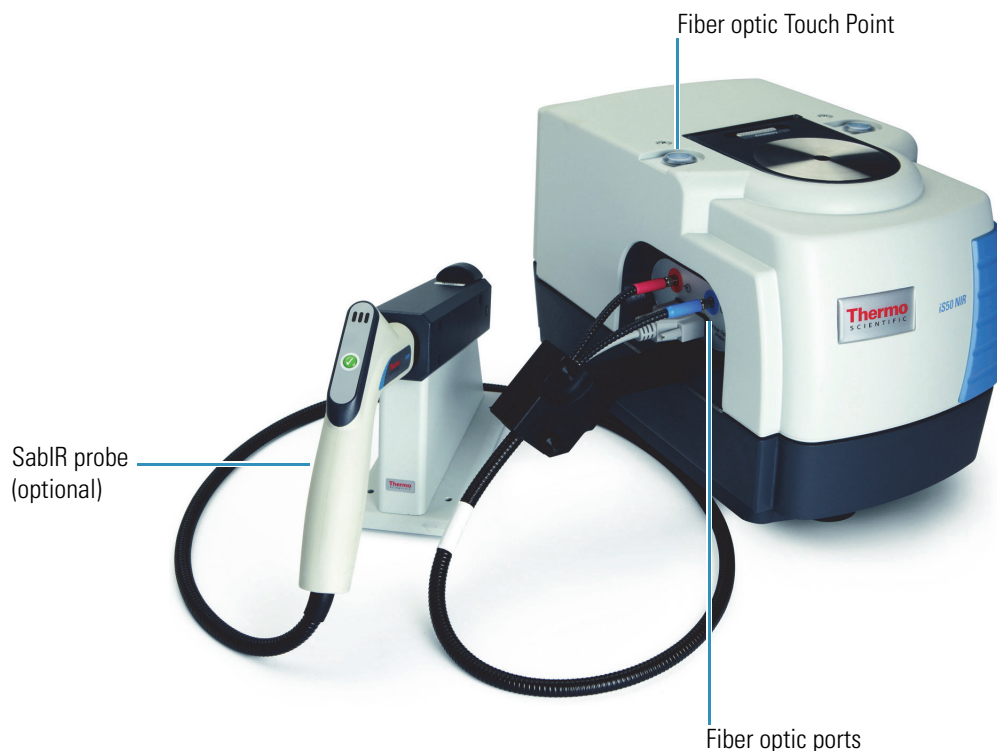

The fiber optic sampling area includes these features:

- **SMA type connectors.**
- **Dedicated InGaAs detector.** The detector offers the same spectral range options as the integrating sphere. Please refer to the “[Specifications](#)” section for details.
- **Touch Point.** Automatically configures the spectrometer for NIR sampling with a fiber optic accessory. The Touch Point LED shows the status of the iS50 NIR module. The LED has three states described below.

**Figure 9.** Fiber optic status indicator states

LED status	Meaning
On	Ready for use
Off	System is not configured for fiber optic sampling
Blinking	Optics are reconfiguring

## Using the Optional SabIR Probe

The fiber optic sampling area is optimized for use with the Thermo Scientific SabIR diffuse reflection probe to provide easy, remote sampling of solids and powders.

**Figure 10.** Optional SabIR diffuse reflection probe



This section covers:

- [SabIR Probe Features](#)
- [Connecting the Strain Relief Mechanism](#)
- [Connecting the SabIR Probe to the NIR Module](#)
- [Samples Compatible with the SabIR Probe](#)
- [Your First Experiment](#)
- [Collecting Backgrounds with the SabIR Probe](#)
- [Sampling Accessories for the SabIR Probe](#)
- [Disconnecting the SabIR Probe](#)
- [Storing the SabIR Probe](#)

## SabIR Probe Features

The major features of the SabIR diffuse reflection probe are highlighted below.

**Figure 11.** SabIR probe features

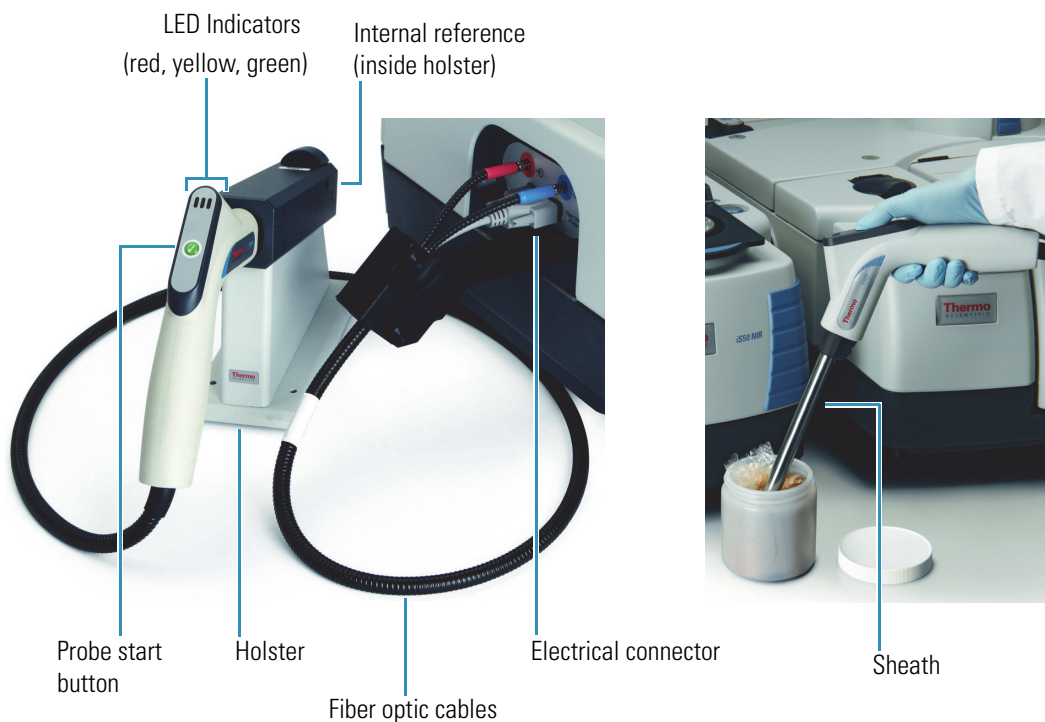

- **Probe and sheath.** The stainless-steel **shaft** has graduated rings to indicate the sampling depth. The **tip** contains an angled sapphire sampling window. The **probe start button** can be used to start or continue sample collection from a remote location. Keep the sheath on the probe shaft when the probe is not connected to the iS50 NIR module.
- **Holster.** The holster is used for taking background collections with the internal reference. **Make sure the probe is clean before you insert it into the holster to avoid contaminating the reference standard.**
- **Fiber optic cables.** Cables are available in two- and three-meter lengths. The cable connectors are color-coded to correlate with the In and Out ports on the NIR module.
- **Electrical connector.** Attaches to the electrical port on the NIR module and is the power source to the probe.
- **LED indicators.** Three LEDs on the probe handle tell you the probe status. The LED states are described below.

**Figure 12.** SabIR probe LED states

LED status	Meaning
Green - steady	Instrument is ready to begin collecting data.
Green - blinking	Instrument is waiting for a response from a software prompt.
Yellow - steady	Probe is collecting data (do not move the probe when the yellow light is on)
Red	An error occurred in the software.

## Connecting the Strain Relief Mechanism

The NIR module includes a strain relief mechanism that prevents the SabIR fiber optic and electrical cables from bending excessively at the connectors. It is easiest to attach the strain relief to the spectrometer before you plug in the connectors for the SabIR probe.

**NOTICE** Make sure you use the strain relief with the SabIR probe to protect the optical fibers when the probe is used for remote sampling.

### ❖ To attach the strain relief mechanism to the iS50 NIR module

1. Align the two pegs and the center thumbscrew on the end of the strain relief mechanism with the holes below the fiber optic connectors.



2. Hand tighten the thumbscrew until the surface of the strain relief mechanism presses firmly against the NIR module.

## Connecting the SabIR Probe to the NIR Module

### NOTICE

- Do not drop the fiber optic cables or the probe or knock them against a hard surface.
- Do not bend the cables or touch the ends, and avoid twisting them when attaching the connectors to the ports or you may contaminate or damage the optical fibers.
- Power off the instrument before connecting the SabIR probe to avoid damaging the electronics.
- Do not use the probe in an explosive environment.
- Save all protective caps so they can be put back on the probe shaft and cable connectors and the fiber optic ports when they are not being used.

### ❖ To connect the SabIR probe to the iS50 NIR module ([watch video](#))

1. Power off the instrument.
2. If the strain relief mechanism is not installed, follow the instructions in the “[Connecting the Strain Relief Mechanism](#)” section to install it.

**NOTICE** Make sure you use the strain relief with the SabIR probe to protect the optical fibers when the probe is used for remote sampling.

3. Remove the cable cover from the strain relief mechanism by loosening the two thumbscrews.



4. Remove the sheath from the SabIR probe tip and insert the probe into the holster.

The probe is in position when you hear it “click” into place.



- Remove the protective caps from the fiber optic cables and from the red and blue ports on the NIR module. Save the caps.

**NOTICE** Do not over tighten or use tools to tighten the connectors or you may damage the connectors on the probe or the NIR module.

- Plug the red connector from the SabIR probe into the red In port on the NIR module, and the blue connector into the blue Out port.

Hand-tighten the connectors until you feel a small amount of resistance, i.e., until they are finger tight.

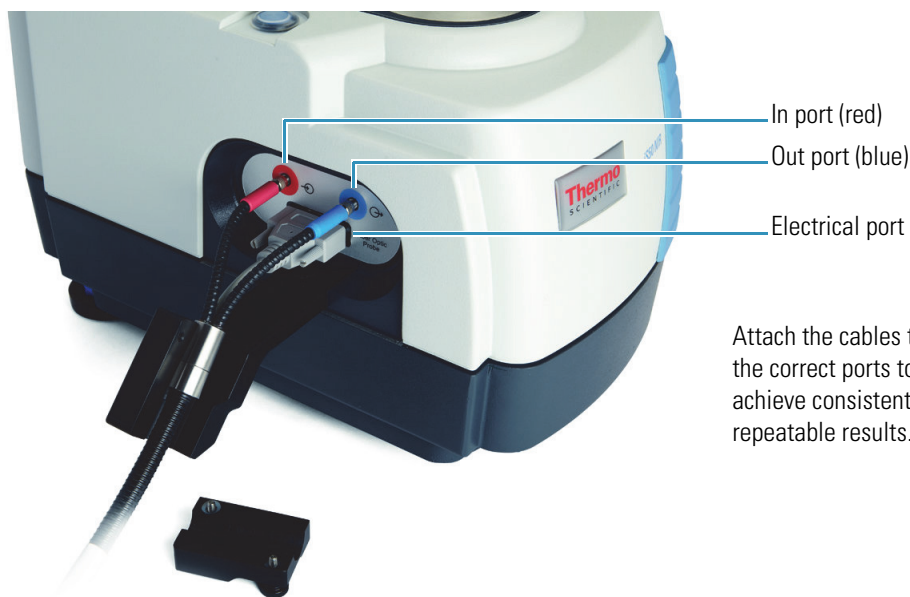

Attach the cables to the correct ports to achieve consistent, repeatable results.

Do not discard the protective caps.  
Replace the caps when the ports are not in use.

7. Connect the electrical cable from the SabIR probe to the electrical port on the NIR module (see the previous image).

**NOTICE**

- Do not bend the cables when fitting them into the strain relief mechanism.
- Make sure the cables are resting in the groove and are not being compressed by the cable cover.

8. Gently maneuver the cables so the silver ring fits in the groove in the strain relief mechanism (see the previous image).
9. Replace the strain relief cover and secure it with the thumbscrews. Make sure the silver ring is completely hidden by the cover.



**CAUTION** Avoid eye hazard. Do not stare at the beam that exits the SabIR sampling window when the SabIR probe is connected to the NIR module and the spectrometer is powered on and the Fiber Optic beam path is selected.

10. Power on the instrument.

If the instrument has been powered off for more than 20 minutes, allow it to stabilize for approximately one hour before collecting data.



## Samples Compatible with the SabIR Probe

The SabIR probe can be used to measure powders and solids that have a rough surface. Some examples are provided below.

### NOTICE

- Make sure your sample materials and cleaning solvents will not react with the sapphire window. Refer to the “[Cleaning the SabIR Probe](#)” section for more information.
- Do not allow hard materials (i.e., glass, metal, ceramic, etc.) to contact the sapphire sampling window.
- Do not use the probe by itself to measure liquids. When sampling liquids, use the transmittance adapter. Refer to the “[Sampling Accessories for the SabIR Probe](#)” section for more information.

**Table 8.** Samples compatible with the SabIR probe

Sample	Type	Examples
Powders <sup>a</sup>	Powders, crystals, granules	Pharmaceutical precursors, sugars, grains, polymer beads
Solids <sup>b</sup>	Must have a rough or diffuse surface	Coated textiles, tablets, paper, wood, polymers, and plastics (especially plastics with a milky, opaque appearance).

<sup>a</sup>May be measured directly in small or large bins, or indirectly through clear packaging such as glass or plastic.

<sup>b</sup>May be measured directly or indirectly through a clear glass or plastic container.

**Sample thickness** or the amount of sample should be taken into consideration when using the SabIR probe. If a solid sample is too thin or if there is not enough of a powder sample, you may encounter problems with the spectra.

**Tip** For repeatable sampling with a homogeneous material, collect the data three times and hold the SabIR in the same position on the sample for each collection.

## Sampling Solids

**NOTICE** Place abrasive solids in a clear glass container or plastic bag before collecting data to avoid damaging the sapphire window.

When sampling a nonabrasive solid, hold the probe tip flush against the surface of the solid. Use enough sample to completely cover the probe window.

**Figure 13.** Sampling a nonabrasive solid with a diffuse reflection probe

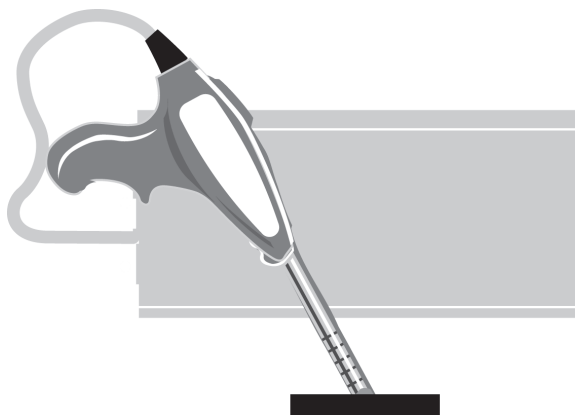

You can also sample solids through clear packaging materials such as plastic bags, plastic wrap, or glass. Sampling through colored packaging materials may affect spectral data.

**Note** Polymeric materials such as plastics have spectral features which may affect analysis results.

### Sampling Powders

You can sample powders directly, or indirectly through clear packaging materials such as glass vials or plastic bags. When sampling a powder through packaging materials, follow the same sampling instructions used for sampling solids.

When sampling powders directly, make sure the sample is thick enough so the probe window is fully covered by the sample material but that enough of the sample material remains underneath the probe window to obtain an accurate reading.

**Figure 14.** Sampling a powder with a diffuse reflection probe

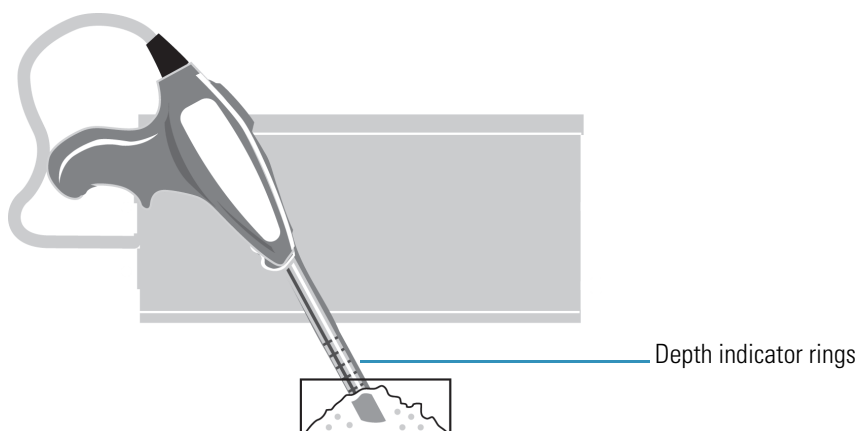

Use the depth indicator rings on the probe shaft to maintain a consistent insertion depth when collecting multiple samples.

## Your First Experiment

This section explains how to configure your fiber optic workflow and demonstrates how to use the SabIR probe to analyze a sample.

### Configuring Your Fiber Optic Workflow

The fiber optic Touch Point has an associated user-configurable workflow that can define everything from background and sample collection to quantitative analysis and spectral search. You simply press the Touch Point to start the workflow. The Touch Point can also be used to respond to prompts in the software while the workflow is running.

#### ❖ To configure your fiber optic workflow

1. Start OMNIC software.

The OMNIC main window is displayed. For information about the OMNIC main window, choose Help > OMNIC Help Topics.

2. Choose the Fiber Optic Touch Point button in the software to configure the instrument for fiber optic sampling.

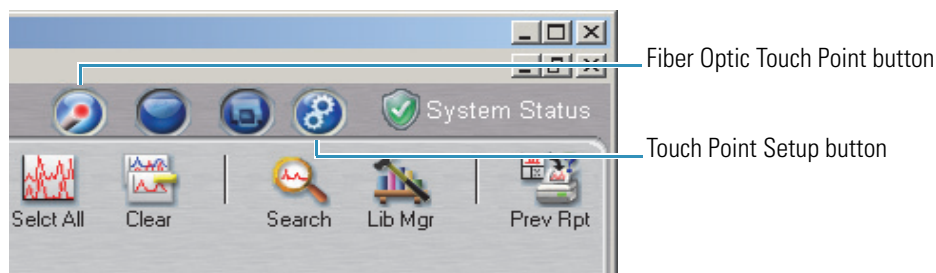

3. Choose the Touch Point Setup button in the software.

A dialog box is displayed.

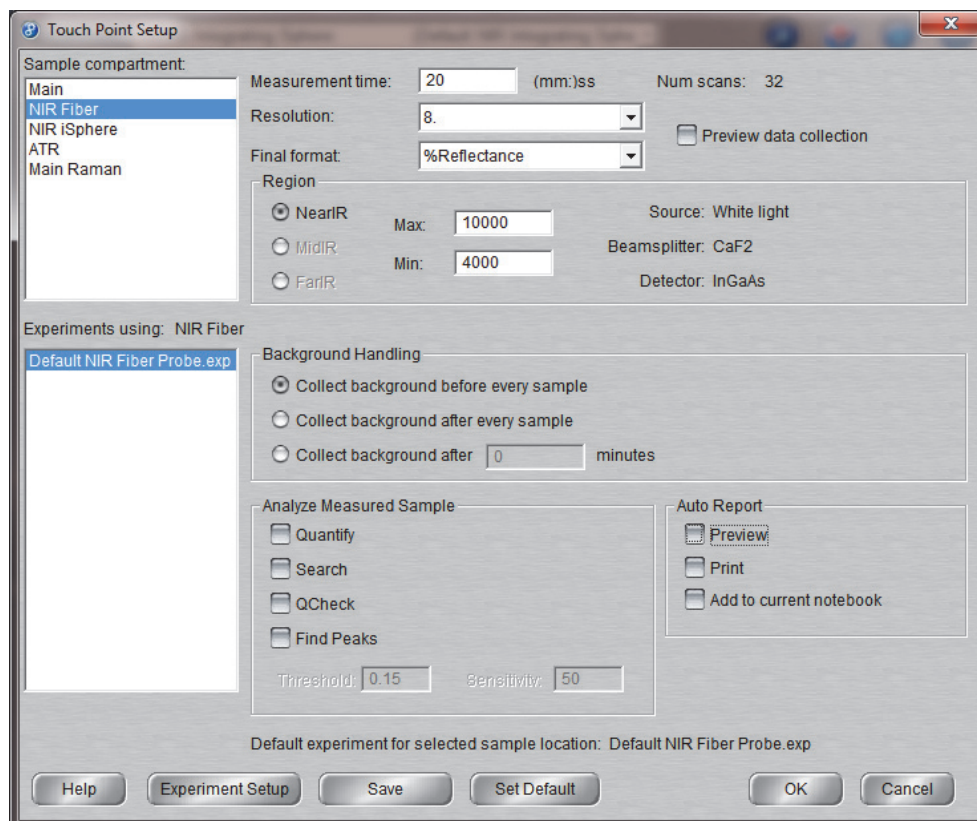

Notice that Sample Location (upper left pane) is set to NIR Fiber, and below that pane is a list of iS50 experiments for the fiber optic sampling area. The selected experiment is highlighted and its associated settings are visible in the dialog box.

The Touch Point dialog box provides commonly used settings that define how your data will be collected, displayed, measured and reported. Except for the spectral range, all of the fiber optic default settings are the same as the default settings for the integrating sphere. For more information, see the “[Configuring Your Integrating Sphere Workflow](#)” section.

4. Select an appropriate experiment in the “Experiments Using: NIR Fiber” pane.
5. Set the Touch Point Setup options as desired.
6. If you want to overwrite the default settings without overwriting the default experiment, choose **Set Default**.
7. Choose **Save**.
8. If you need to specify other experiment settings, choose **Experiment Setup**, set the options as desired, choose **Save** and then choose **OK** to close Experiment Setup. For more information, choose **Help** from Experiment Setup.

**Note** Some settings appear in Experiment Setup and Touch Point Setup. Setting these options in one location automatically changes them in the other.

9. Choose OK to close the Touch Point Setup dialog box.

## Measuring a Sample with the SabIR Probe

### Before You Begin

- Power on the spectrometer and allow the instrument to stabilize for at least an hour (if the instrument has been powered off for more than 20 minutes).
- Make sure the probe window is clean. Refer to the “[Cleaning the SabIR Probe](#)” section for instructions and recommended solvents.
- Have your sample material at hand. For the collection settings in the default workflow, choose one of the following items for your sample:
  - a piece of fabric, or
  - A small clear glass or plastic container filled with sugar or another granular solid (we use polymer beads for this demonstration).

**Figure 15.** Sample ready for measurement with the SabIR probe



**CAUTION** Avoid eye hazard. Do not stare at the beam that exits the SabIR sampling window when the SabIR probe is connected to the NIR module and the spectrometer is powered on and the Fiber Optic beam path is selected.

❖ **To measure a sample with the Thermo Scientific SabIR probe (watch video)** 

1. Press the fiber optic Touch Point to configure the instrument for fiber optic sampling.

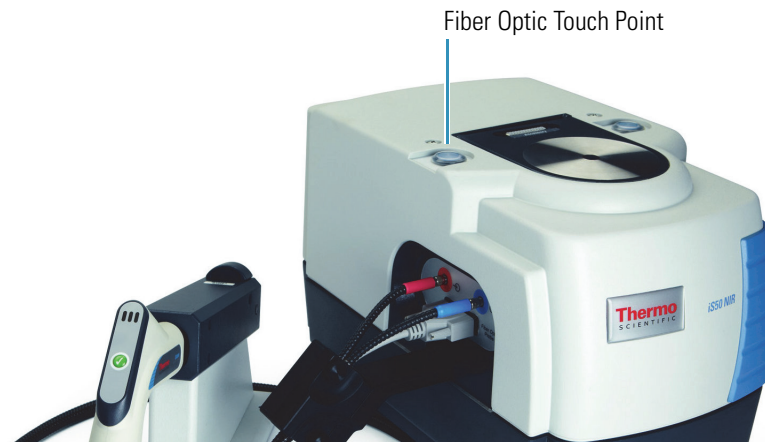

A message may be displayed while the instrument collects scans to determine instrument stability with the new configuration.

2. Wait until the stability test is completed, or choose **OK** or **Cancel** to skip the test.
3. If your fiber optic workflow is not configured, follow the steps in the “[Configuring Your Fiber Optic Workflow](#)” section to configure it.
4. Press the fiber optic Touch Point to start the workflow.

If the workflow is set up to collect a dark correction spectrum (that is, if Dark Correct is selected on the Bench tab in Experiment Setup), a message asks you to prepare to collect a dark correction spectrum. Follow these steps to collect the correction spectrum:

- a. Remove the SabIR probe from the holster (do not press the probe start button).
- b. Point the probe tip upward (not directed at any person) and then press and release the button on the probe handle (or press the fiber optic Touch Point on the instrument) to collect the spectrum. The LED on the probe handle changes from green to yellow when the probe starts collecting data. Keep the probe still during the measurement.

When the spectrum is completed, a message asks whether to add it to an OMNIC spectral window.

- c. Choose **Yes** or **press the Touch Point**. The spectrum is saved whether or not it is added to a window.
- d. Insert the probe shaft into the holster and press on the handle until you hear the probe “click” into place.

If the workflow is not set up to collect a dark correction spectrum, a message asks for a spectrum title.

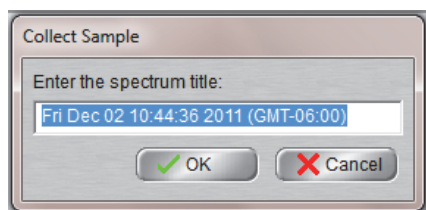

5. Enter a title for your sample spectrum and choose **OK** or press the fiber optic Touch Point or the probe start button.

If the software has no appropriate background spectrum in memory and the workflow is set up to collect a background using the internal reference, the software begins collecting a background spectrum from the Spectralon reference mounted in the holster. The background spectrum is added to the selected OMNIC spectral window and a message asks you to prepare for the sample collection. The green LED on the probe handle should be on.

**Note** If the workflow is configured to collect a background using an external reference, a message asks you to prepare for the background collection. Gently hold the probe tip against the reference material and then press and release the probe start button (or press the fiber optic Touch Point) to start the measurement. When the background measurement is completed, the spectrum is added to the selected window and a message asks you to prepare for the sample collection. See the “[Backgrounds Taken with an External Reference](#)” section for examples of materials that can be used as an external reference.

6. Remove the probe from the holster (do not press the probe start button) and dip the tip in the sample so the window is completely covered. (There must be a thick layer of sample below the window to get an accurate reading.)

If the sample is in a container, hold the probe tip flush against the container surface. Use enough sample to completely cover the probe window.

**Figure 16.** Powder sample ready for measurement with a diffuse reflection probe



For more information, refer to the “[Sampling Solids](#)” and “[Sampling Powders](#)” sections.

7. When the probe is in position, press and release the button on the probe handle (or press the fiber optic Touch Point) to collect the sample data.

Do not move the probe until the yellow light on the probe handle has turned off. When the spectrum is completed, a message asks whether to add it to a window.

8. Choose **Yes** or **press the probe button or the fiber optic Touch Point** to add the spectrum to the selected window and complete the workflow.

If your workflow specifies an analysis such as quantify or search, those steps occur automatically. To see the analysis results, choose the “r” button to the left of the title box above the spectral window.

The sample spectrum and any analysis results that were run on the data are stored in a virtual auto report. If your workflow is set up to preview or print auto reports, the report is displayed or printed on the default printer. Below is an example report showing a diffuse reflection spectrum of a polymer taken with the iS50 NIR module and SabIR probe.



**Figure 17.** Auto report showing a diffuse reflection spectrum of a polymer taken with the iS50 NIR module and Thermo Scientific SabIR probe

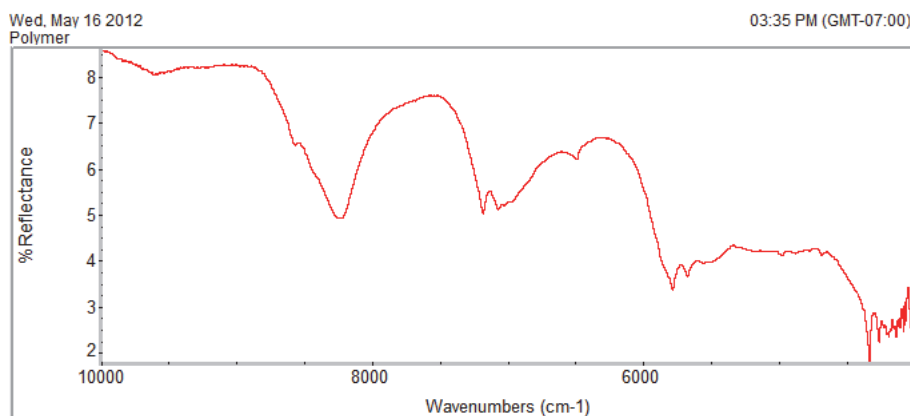

9. Clean the probe tip.

Pour a small amount of cleaning solution (one part isopropyl alcohol with nine parts water) onto a soft cloth and gently rub the cloth on the probe shaft.

Using an eye-dropper, place a small amount of the cleaning solution on a clean piece of lens paper and then gently rub the paper on the optical window.

10. Insert the shaft into the holster until you hear it “click” in place.

## Collecting Backgrounds with the SabIR Probe

A background is a reference spectrum that accounts for the unique optics of the sampling accessory and the instrument. Each sample spectrum is ratioed against a background so that the final spectrum is free of these features.

You can collect a background with the SabIR probe using the internal Spectralon reference or an external reference. The workflow should indicate which kind of reference should be used. The workflow will also direct how often to collect a background spectrum. The most recent background spectrum remains in memory and is compared against sample data until a new background spectrum is collected.

The “NIR Sampling” section contains suggestions if a background spectrum is atypical from previously collected background spectra.

### Backgrounds Taken with the Internal Reference

The SabIR probe holster contains a Spectralon reference that can be used for collecting backgrounds. Spectralon is a very diffuse substance with high reflectance, but it is a soft, porous material that must be handled carefully. It can be cleaned if it becomes dirty. Please refer to the “[Cleaning the Spectralon Background Reference](#)” section for instructions on how to handle and clean the reference.

**NOTICE** Make sure the probe sheath and window are clean before you insert the probe into the holster.

The instrument automatically detects when the probe is properly inserted in the holster and the software can collect a background automatically without any operator prompts. While the instrument is collecting data, the yellow indicator light on the probe handle will be on. Do not remove the probe from the holster until the yellow light turns off.

A typical background spectrum using the Spectralon reference should resemble the following.

**Figure 18.** Typical Spectralon background spectrum taken with the iS50 NIR module and Thermo Scientific SabIR probe

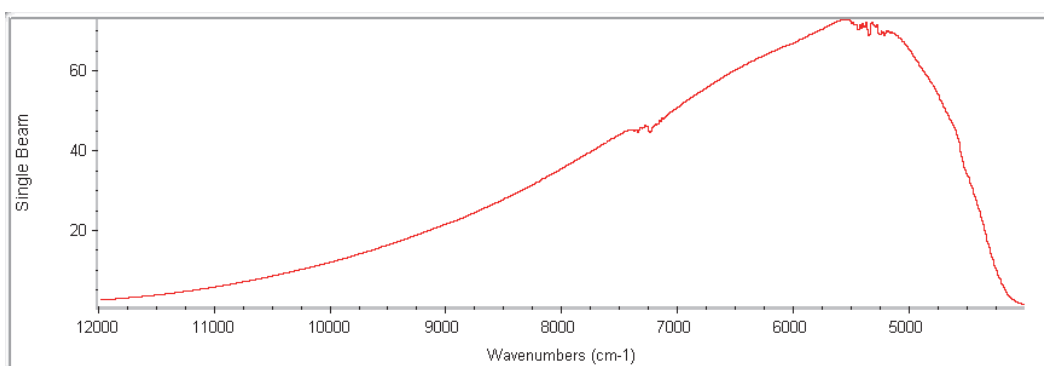

### Backgrounds Taken with an External Reference

When the fiber optic workflow is configured to collect a background using an external reference, the workflow prompts for a reference before background collection begins. Some examples of materials that can be used as an external background reference include:

- Spectralon
- Diffuse gold
- Ceramic or sintered polytef plate (solids)
- Barium sulfate, polytetrafluoroethylene (powders)

**Tip** Once a material is selected for a background reference, make sure to use the same material each time you run the workflow.

Hold the probe to the reference material if the reference is a solid (or dip the probe in the reference if it is a powder) and then press and release the button on the probe handle (or press the fiber optic Touch Point) to start collecting the data. While the instrument is collecting data, the yellow indicator light on the probe handle will be on. Do not move the probe until the yellow light turns off.

## Sampling Accessories for the SabIR Probe

Optional Thermo Scientific accessories for the SabIR probe are described briefly below. To order an accessory, contact our local sales or service representative or see our contact information at the beginning of this document or help system.

**Table 9.** Optional Thermo Scientific accessories for the SabIR probe

<i>This accessory...</i>	<i>Does this...</i>
<p data-bbox="431 541 776 575">SabIR Transflectance Adapter</p> 	<p data-bbox="954 541 1468 718">Slides on the SabIR probe shaft and allows you to analyze liquids using the transflectance sampling technique. For detailed information about the SabIR Transflectance Adapter, see the document or help topic with that title.</p>

SabIR probe and transflectance adapter used to measure a liquid sample



Probe stand



Secures the SabIR probe for repeatable measurements where the tip angle and pathlength are important such as measurements with an external standard.

SabIR probe properly fitted in probe stand



## Disconnecting the SabIR Probe

It is not necessary to disconnect the SabIR probe from the iS50 NIR module after each use. However, if you are not planning to use the probe for a long period of time, or if you need to remove it to attach a different accessory, follow these steps to disconnect the probe.

**NOTICE** Power off the instrument before you disconnect the SabIR probe to avoid damaging the instrument's electronics.

❖ **To disconnect the Thermo Scientific SabIR probe (watch video)** 

1. Power off the instrument.

**NOTICE** To avoid contaminating the internal reference, make sure the probe shaft and tip are clean before you insert the probe into the holster.

2. Insert the SabIR probe into the holster to avoid causing strain on the fiber optic cables from the weight of the probe.

1. Remove the strain relief cable cover by loosening the two captive thumbscrews.



2. Gently remove the cables from the groove in the strain relief base. (It is not necessary to remove the strain relief base.)

**NOTICE**

- Do not bend the fiber optic cables or touch the ends, and avoid twisting them when detaching the connectors from the ports or you may contaminate or damage the optical fibers.
- Do not tightly coil the cables. The radius of the coils for the SabIR probe should be at least 30 cm.

3. Disconnect the SabIR fiber optic cables from the ports (see the previous image).
4. Disconnect the SabIR electrical cable (see the previous image).
5. Replace the sheath on the probe shaft.
6. Replace the protective caps on the ends of the cables and the fiber optic ports.
7. Replace the strain relief cable cover.

## Storing the SabIR Probe

Store the SabIR probe in a dust-free environment such as a cabinet or its original shipping box.

### NOTICE

- Do not bend the fiber optic cables or tightly coil them to avoid damaging the optical fibers. The radius of the coils for the SabIR probe should be at least 30 cm.
- Place the sheath on the probe shaft and the protective caps on the fiber optic cable connectors and the ports on the iS50 NIR module when they are not being used.

## Using Fiber Optic Accessories from Other Manufacturers

This section covers:

- [Connecting a Fiber Optic Sampling Accessory](#)
- [Collecting Data](#)

### Connecting a Fiber Optic Sampling Accessory

#### ❖ To connect a fiber optic sampling accessory to the iS50 NIR module

1. Remove any protective caps from the sampling accessory connectors.

Save the caps so they can be put back onto the accessory before it is stored.



**CAUTION** Avoid eye hazard. Do not stare at the beam that exits the fiber optic ports, or the fiber optic cables when they are connected to the ports, when the spectrometer is powered on and the Fiber Optic beam path is selected.

2. Remove the protective caps from the In and Out fiber optic ports on the iS50 NIR module. Save the caps.

3. Connect the SMA connector from your sampling accessory to each fiber optic port.

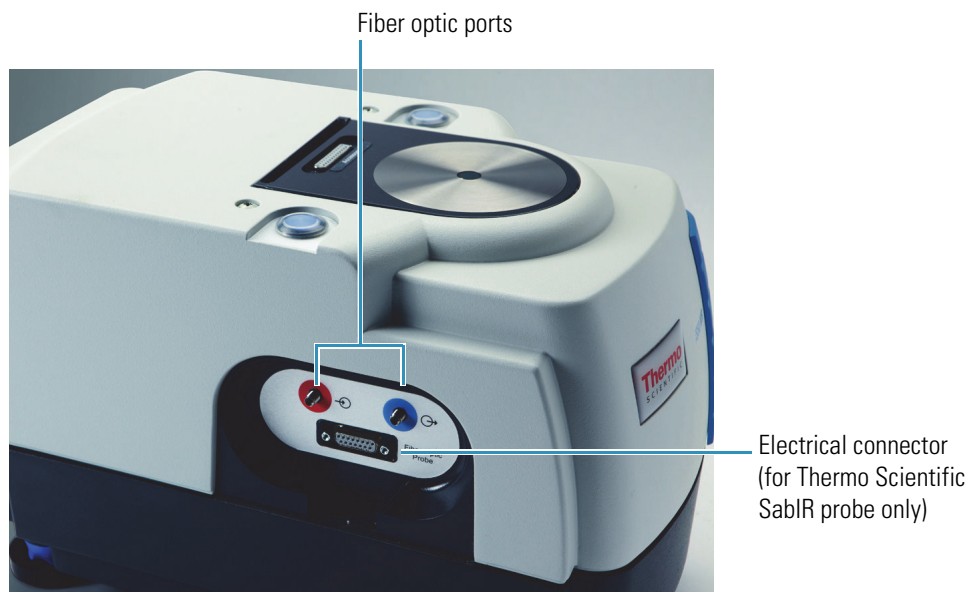

The near-infrared beam travels out the blue “out” port and into the fiber optic accessory. The light leaves the accessory and travels back into the module through the red “in” port. Use the color coding to assist you in consistently connecting the cables on your sampling accessory to the same ports on the module.

**Tip** It is important to consistently attach the fiber optic cables to the same ports when connecting sampling accessories. If there are differences between the fiber optic cables, and they are not always attached to the same ports, your data may be affected.

**NOTICE** Do not over tighten the connectors or use tools to tighten them or you may damage the connectors on the accessory or the iS50 NIR module.

4. Hand-tighten the connectors until you feel a small amount of resistance, that is, until they are finger tight.

## Collecting Data

Select a background material and sample that is compatible with your fiber optic accessory. Refer to the documentation that came with the accessory for information about compatible samples.

To collect the data, follow the steps in the “[Your First Experiment](#)” section using the fiber optic Touch Point or the software to continue to the next step. Do not move the sampling accessory until the instrument has completed collecting data.

## Maintenance

This section describes maintenance routines that you can perform on the iS50 NIR module to keep it running efficiently. This section covers:

- [Cleaning the NIR Module Housing](#)
- [Cleaning the Integrating Sphere Sampling Window](#)
- [Cleaning Integrating Sphere Sampling Accessories](#)
- [Cleaning the SabIR Probe](#)
- [Cleaning the Spectralon Background Reference](#)

### Cleaning the NIR Module Housing

#### NOTICE

- Do not pour liquids directly onto the sampling area of the integrating sphere, especially the area around the electrical port for the Sample Spinner.
- Do not use harsh detergents, chemicals or abrasives to clean the surface of the integrating sphere; these can damage the finish.

Use a damp (not wet), soft cloth and a mild soap to clean the integrating sphere cover and other metal parts, including the sample accessory holder. Dry them with a clean cloth.

**Figure 19.** Sample accessory holder

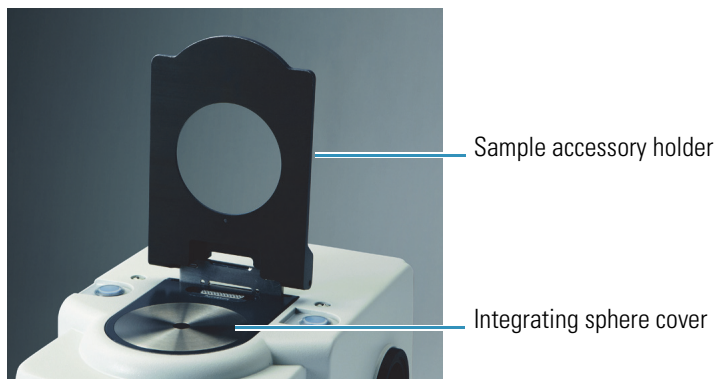



## Cleaning the Integrating Sphere Sampling Window

### NOTICE

- The cleaning fluid should be at or close to room temperature (or the temperature of the previous sample). Applying extremely hot or cold liquids to the sampling window may crack it.
- Some chemicals including acetone, chlorine, fluorine, and amyl alcohol can attack the epoxy seal around the sampling window. Do not allow these chemicals to come into contact with the window.



**CAUTION** Avoid eye hazard. Do not stare at the beam that exits the integrating sphere sampling window when the spectrometer is powered on and the Integrating Sphere beam path is selected.

### ❖ Cleaning the integrating sphere sampling window

1. Remove any sample, sample cup or accessory from the integrating sphere.
2. If the sample came in contact with the sampling window, gently clean the window with a clean, white paper napkin or cotton ball moistened with methanol, ethanol, isopropyl alcohol or water.
3. Dry the window with a clean napkin or cotton ball. Avoid materials that have been treated with aloe or other additives.

### Tip

- Chemical wipes such as Kimwipes™ are not recommended for cleaning the integrating sphere sampling window as embedded clays can make these slightly abrasive.
- Use of soaps or other surfactants for cleaning the sampling window is discouraged as these can leave a residue bound to the window surface.

## Cleaning Integrating Sphere Sampling Accessories

*To clean this accessory...*

Sample cups

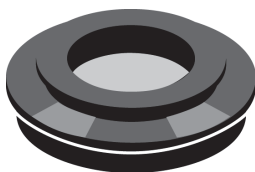

*Do this...*

Use a mild soap solution and then rinse with distilled water. Dry them with a jet of clean air or a non-abrasive cloth or paper napkin.

### Notice

Do not use harsh solvents to clean the sample cups or you may damage them.

---

Custom tablet holder

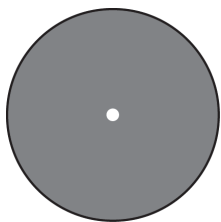

Use a mild soap solution and then rinse with distilled water. Dry them with a jet of clean air or allow to air dry.

**Notice**

Do not use harsh solvents to clean the custom tablet holders or you may damage them.

---

Sample rings

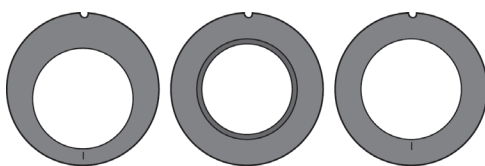

Use a dry, soft cloth or dampen it with isopropyl alcohol, distilled water, or a mild soap solution. Dry them with a clean cloth or allow to air dry.

**Notice**

Do not use harsh solvents to clean the sample rings or you may damage them.

---

Universal tablet holder

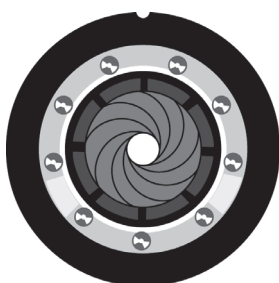

Use a jet of clean air to remove any particles. If this is not sufficient, then gently rub the tablet holder with a cloth dampened with isopropyl alcohol and let it air dry.

**Notice**

- Do not use water to clean the universal tablet holder or it may rust.
- The iris is delicate; handle it gently.

## Cleaning the SabIR Probe

If the tip or shaft of the SabIR probe becomes dirty or contaminated with sample or other material, prepare a cleaning solution of one part isopropyl alcohol and nine parts water in a clean container and follow these instructions.

### NOTICE

- The cleaning fluid should be at or close to room temperature (or the temperature of the previous sample). Applying extremely hot or cold liquids may crack the sapphire sampling window.
- Some chemicals including acetone, chlorine, fluorine and amyl alcohol can attack the epoxy seal around the sapphire window. Do not allow these chemicals to come into contact with the window.



**CAUTION** Avoid eye hazard. Do not stare at the beam that exits the SabIR sampling window when the SabIR probe is connected to the NIR module and the spectrometer is powered on and the Fiber Optic beam path is selected.

### ❖ To clean the Thermo Scientific SabIR probe ([watch video](#))

1. Remove the SabIR probe from the holster.
2. Pour a small amount of the cleaning solution onto a soft cloth and use it to gently clean the probe shaft. Allow the shaft to air dry.
3. Using an eye-dropper, place a small amount of the cleaning solution on a fresh piece of lens paper.
4. Gently rub the lens paper on the optical window for 10 to 20 seconds.

Allow the window to air dry for at least two minutes.

### Tip

- Chemical wipes such as Kimwipes are not recommended for cleaning the SabIR probe sampling window as embedded clays can make these slightly abrasive.
- Use of soaps or other surfactants for cleaning the window is discouraged as these can leave a residue bound to the window surface.

## Cleaning the Spectralon Background Reference

Spectralon is an optical standard and should be handled with care. Keep the Spectralon reference in the SabIR probe holster at all times unless you need to clean or replace it.

**NOTICE** Avoid touching the surface of the Spectralon reference. Dirt and oils from your fingers can leave residue which will affect background spectra quality.

### ❖ To clean the Spectralon reference

1. Put on a pair of clean gloves or finger cots.
2. Remove the SabIR probe from the holster and place it securely on a table.
3. Firmly grasp both sides of the reference holder with your thumb and forefinger and pull it out of the holster.

**Figure 20.** Removing the Spectralon reference

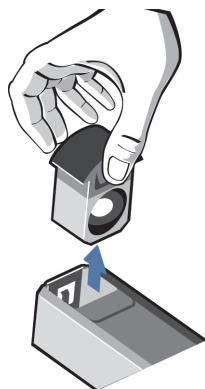

Remove the SabIR probe from the holster before you attempt to remove the reference holder.

4. Clean the Spectralon surface with an air brush, using clean, dry air or nitrogen.
5. If this is insufficient, gently sand the surface with a 220-240 grit waterproof emery cloth.
6. If the surface is still not sufficiently clean, sand it under running water with a 220-240 grit waterproof emery cloth until water beads and immediately runs off the surface. Dry the surface with a jet of clean, dry air or nitrogen, or allow the material to air dry.

If the background quality does not improve after thoroughly cleaning the Spectralon reference, the reference may need to be replaced. Contact our sales or service representative in your area for more information.

# Index

## Symbols

- %Reflectance
  - NIR module display format, selecting 10

## A

- accessories
  - for NIR integrating sphere 18
  - for SabIR probe 41
- accessory
  - holder for NIR integrating sphere 18
  - Sample Spinner 19
  - Viscous Liquid Sampler 19
- adapter
  - for SabIR transmittance measurements 41
- agents
  - recommended for integrating sphere window 47
- annotating, sample peaks
  - NIR module 11
- auto report 39
  - NIR integrating sphere 16
  - SabIR probe 39
- Auto Report options
  - NIR module, setting 11
- averaging
  - NIR module scans 9

## B

- background
  - collect external with NIR integrating sphere 15
  - collect external with SabIR probe 37
  - collect internal with NIR integrating sphere 15
  - collect internal with SabIR probe 37
  - external for NIR integrating sphere 17
  - external for SabIR probe 40
  - internal for NIR integrating sphere 16
  - internal for SabIR probe 39
  - SabIR probe, described 39
  - set frequency for NIR module 10
  - typical internal for NIR integrating sphere 17

- typical internal for SabIR probe 40
- Background Handling option
  - set for NIR module 10
- background spectrum
  - described for NIR integrating sphere 16
  - described for SabIR probe 39
- beam port
  - window material for NIR module 4
- beamsplitters
  - available for NIR module 4
- button
  - fiber optic Touch Point 33
  - integrating sphere Touch Point 8
  - Touch Point Setup 8, 33

## C

- cables
  - See fiber optic cables
- centering sample cup ring 18
- clean
  - custom tablet holder 48
  - integrating sphere window 47
  - NIR module housing 46
  - SabIR probe 49
  - SabIR reference 50
  - sample cups 47
  - sample rings 48
  - Universal Tablet Holder 48
- cleaning agents
  - for SabIR probe 49
  - recommended for integrating sphere window 47
- coadd
  - NIR module scans 9
- collect
  - data using fiber optic probe 45
  - data using integrating sphere 12
  - data with SabIR probe 35
- concentration
  - calculate with NIR module 10
- concentric sample cup ring

## Index: D

- described 18
- using 20
- configure
  - integrating sphere workflow 8
  - SabIR workflow 33
- connector
  - NIR fiber optic 4
- correction spectrum
  - dark for NIR integrating sphere 14, 17
  - dark for SabIR probe 36
- correlation values for spectra
  - calculate with NIR module 11
- crystal
  - specifications for NIR integrating sphere 4
- crystals
  - measurable with SabIR probe 31
- cup
  - sample, 5 cm 18
- custom tablet holder
  - cleaning 48
  - described 19
  - using 23

## D

- dark correction spectrum
  - described 17
  - for NIR integrating sphere 14
  - for SabIR probe 36
- data collection
  - preview with NIR module 10
- default experiment
  - for NIR module 11
  - for SabIR probe 34
- detector
  - NIR fiber optic 4, 24
  - NIR integrating sphere 4
- diffuse reflection
  - with NIR integrating sphere 5
  - with SabIR probe 25

## E

- eccentric sample cup ring
  - described 18
  - using 20
- experiment
  - default for NIR integrating sphere 9
  - default for SabIR probe 34
- Experiment Setup options
  - overlapping with Touch Point options 12, 35
- external background
  - collect with NIR integrating sphere 15

- collect with SabIR probe 37
- described for NIR integrating sphere 17
- described for SabIR probe 40
- external beam port
  - See also* beam port, external
- external reference
  - holder for SabIR probe 42

## F

- far-IR region
  - select for NIR module 10
- fiber optic cables
  - operating precautions 3
  - SabIR probe 26
- fiber optic probe
  - collect data 45
  - connect to NIR module 44
- fiber optic Touch Point button
  - location 33
- Final Format option
  - set for NIR module 10
- Find Peaks option
  - set for NIR module 11

## G

- gels
  - measurable with integrating sphere 7
- granules
  - measurable with integrating sphere 7
  - measurable with SabIR probe 31

## H

- holder
  - reference for SabIR probe 42
- holster
  - for SabIR probe 26

## I

- identify unknown sample
  - using NIR module 11
- InGaAs detector
  - NIR fiber optic 4
  - NIR integrating sphere 4
- integrating sphere
  - See also* NIR integrating sphere
  - default experiment 11
- internal background
  - collect with NIR integrating sphere 15
  - collect with SabIR probe 37
  - described for NIR integrating sphere 16

- for SabIR probe 39
- typical for NIR integrating sphere 17
- typical for SabIR probe 40
- internal reference
  - See also* reference, internal

## L

- libraries, reference
  - selecting for NIR search 11
- limits, spectral range
  - NIR module 10
- liquid sample holder
  - described 19
- liquids
  - and SabIR sampling 41
  - measurable with integrating sphere 7
- log(1/R) Y-axis unit
  - select for NIR module 10

## M

- Max/Min options
  - set for NIR module 10
- Measurement Time option
  - set for NIR module 9
- method, quantitative analysis
  - select for NIR module 10

## N

- Nicolet iS50
  - connect SabIR strain relief 27
- NIR fiber optic 23
  - connect probe 44
  - connector type 4
  - detector 4, 24
  - features 24
  - SabIR probe 25
  - SabIR probe LED states 26
  - specifications 4
  - Touch Point 24
  - Touch Point LED states 24
  - Touch Point Setup dialog box 34
- NIR integrating sphere 5
  - auto report 16
  - background spectrum, described 16
  - clean sampling window 47
  - collect dark correction spectrum 14
  - collect external background 15
  - collect internal background 15
  - compatible samples 7
  - dark correction, described 17
  - default experiment 9

- detector 4
- enter spectrum title 14
- external background 17
- features 6
- internal background described 16
- internal reference
  - specification 4
- measure solid 12
- operating precautions 3
- performance test 14
- sampling accessories 18
- sampling window 6
- specifications 4
- stability test 14
- status indicator states 7
- Touch Point 6
- Touch Point Setup dialog box 9
- typical internal background 17
- NIR module
  - clean housing 46
  - compatible software 5
  - default experiment 11
  - major features 1
  - methods
    - to create 5
    - used with RESULT software 5
  - spectral range 4
  - window material 4
- Number of Scans readout
  - NIR module 9

## O

- offset sample cup ring 18
- OMNIC software, described 5
- OMNIC Spectra software, described 5

## P

- peaks, sample
  - find with NIR module 11
- pellets
  - measurable with integrating sphere 7
- powders
  - measurable with integrating sphere 7
  - measurable with SabIR probe 31
  - to measure with SabIR probe 32
- precautions, operating
  - fiber optic cables 3
  - NIR integrating sphere 3
  - SabIR probe 3
- Preview Auto Report option
  - set for NIR module 11

## Index: Q

Preview Data Collection option  
  set for NIR module 10  
Print Auto Report option  
  set for NIR module 11  
probe  
  See also SabIR probe  
  collect data 45  
  connect strain relief 27  
  connect to NIR module 44  
  SabIR 25  
probe stand 42

## Q

QCheck option  
  set for NIR module 11  
Quantify option  
  set for NIR module 10  
quantitative analysis method  
  select for NIR module 10

## R

reference  
  clean SabIR 50  
  external for integrating sphere 17  
  external for SabIR probe 40  
  internal for integrating sphere 16  
  internal for NIR integrating sphere 4  
  internal for SabIR probe 4, 39  
  typical internal for integrating sphere 17  
  typical internal for SabIR probe 40  
reference holder  
  for SabIR probe 42  
reference libraries  
  selecting for NIR search 11  
Region option  
  set for NIR module 10  
repeatability  
  improve for integrating sphere 20  
  improve for SabIR probe 42  
report, auto  
  for NIR integrating sphere 16  
  for SabIR probe 39  
reporting options  
  set for NIR module 11  
Resolution option  
  set for NIR module 9  
RESULT software  
  and NIR module methods 5  
  described 5  
rings  
  cleaning 48

## S

SabIR probe 25, 39  
  and sample thickness 31  
  background described 39  
  clean reference 50  
  cleaning 49  
  collect external background 37  
  collect internal background 37  
  compatible samples 31  
  configure workflow 33  
  connect strain relief 27  
  connecting 28  
  default experiment 34  
  disconnecting 42  
  electrical connector 29  
  enter spectrum titled 37  
  external background 40  
  features 26  
  how to measure powder 32  
  how to measure solid 31  
  improve repeatability 31, 42  
  internal background 39  
  internal reference 4  
  LED states 26  
  measure sample 35  
  operating precautions 3  
  red, blue connectors 29  
  sampling accessories 41  
  stand 42  
  storing 44  
  typical internal background 40  
SabIR Transflectance Adapter 41  
sample  
  identify unknown with NIR module 11  
  measure with integrating sphere 12  
  measure with SabIR probe 35  
  thickness for SabIR probe 31  
sample accessory holder  
  for NIR integrating sphere 18  
  install 20  
  remove 20  
sample collection  
  preview with NIR module 10  
sample cup  
  cleaning 47  
sample cup holder  
  for NIR integrating sphere 18  
sample cup rings 18  
  installing 21  
  using 20  
sample cups  
  5 cm 18  
  filling 21



- sample peaks
    - find with NIR module 11
  - sample rings
    - cleaning 48
  - Sample Spinner accessory 19
  - samples
    - compatible with NIR integrating sphere 7
    - compatible with SabIR probe 31
  - sampling
    - NIR fiber optic 23
    - NIR integrating sphere 12
  - sampling window
    - clean for integrating sphere 47
    - clean for SabIR probe 49
    - described for integrating sphere 6
    - described for SabIR probe 26
  - scans
    - NIR module
      - averaging 9
      - setting 9
  - Search option
    - set for NIR module 11
  - Sensitivity option
    - set for NIR module 11
  - settings
    - NIR fiber optic Touch Point 34
    - NIR integrating sphere Touch Point 9
  - sheath
    - SabIR probe 26
  - similarities between spectra
    - finding with NIR module 11
  - software
    - compatible with NIR module 5
    - OMNIC Spectra, described 5
    - OMNIC, described 5
    - RESULT, described 5
    - TQ Analyst, described 5
  - solid
    - measure with NIR integrating sphere 12
    - measure with SabIR probe 31
  - solids
    - measurable with integrating sphere 7
    - measurable with SabIR probe 31
  - source
    - available for NIR module 4
  - specifications
    - NIR fiber optic 4
    - NIR integrating sphere 4
  - spectra, reference
    - selecting for NIR search 11
  - spectral range
    - available for NIR module 4
    - set for NIR module 10
  - spectral resolution
    - set for NIR module 9
  - Spectralon reference
    - cleaning 50
    - for SabIR probe 4
  - spectrum
    - dark correction for NIR integrating sphere. 14
    - enter title 37
  - sphere
    - See also* NIR integrating sphere
  - status indicator
    - fiber optic sampling area 24
    - NIR integrating sphere 7
    - SabIR probe 27
  - strain relief
    - connecting 27
- ## T
- tablet
    - measure with integrating sphere 13
  - tablet holders
    - cleaning 48
    - for NIR integrating sphere 19
  - tablets
    - measurable with integrating sphere 7
  - Threshold option
    - set for NIR module 11
  - time
    - measurement for NIR module 9
  - title
    - enter spectrum with NIR integrating sphere 14
    - enter spectrum with SabIR probe 37
  - Touch Point
    - NIR fiber optic 24
    - NIR integrating sphere 6
  - Touch Point button
    - fiber optic 33
    - integrating sphere 8
  - Touch Point options
    - overlapping with Experiment Setup options 12, 35
  - Touch Point Setup button 8
    - location 33
  - Touch Point Setup dialog box
    - NIR fiber optic settings 34
    - NIR integrating sphere settings 9
  - TQ Analyst methods
    - used with OMNIC and RESULT software 5
  - TQ Analyst software, described 5
  - transflectance
    - adapter for SabIR probe 41

## Index: U

transflection accessory  
for integrating sphere 19  
for SabIR probe 41

## U

unit  
select Y-axis for NIR module 10  
Universal Tablet Holder  
adjust iris 22  
clean 48  
described 19  
install 22  
unknown sample  
identify with NIR module 11

## V

Viscous Liquid Sampler  
described 19

## W

window  
beam port for NIR module 4  
clean for integrating sphere 47  
clean for SabIR probe 49  
sampling for integrating sphere 6  
sampling for SabIR probe 26  
workflow  
configure for integrating sphere 8  
configure for SabIR probe 33

## Y

Y-axis unit  
NIR module, setting 10